

Mechanical Key Switch (SMD)

B3FS

Surface-mounting Switches Ideal for High-density Mounting

- Tape packing style also available.
- Allows reflow soldering.
- Incorporates a snap-action contact mechanism that ensures sharp switching operations.

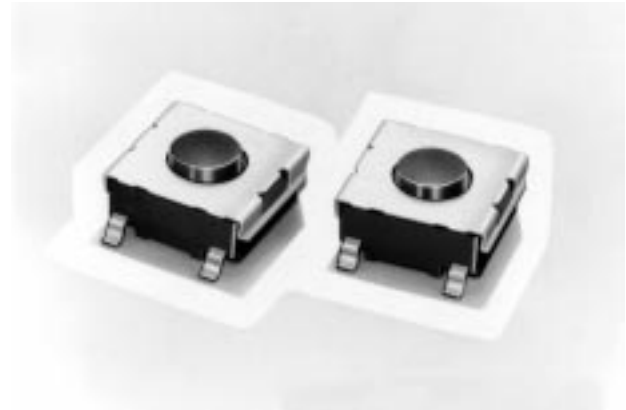

Ordering Information

■ Model Number Legend

B3FS-□□□□□
1 2 3 4 5

- | | |
|---|---|
| <p>1. Appearance
1: 6 mm x 6 mm</p> <p>2. Ground Terminal
0: None</p> <p>3. Height
0: 3.1 mm</p> | <p>4. Operating Force (OF)
0: 100 gf
2: 150 gf</p> <p>5. Shipment Package
---: Bag
P: Embossed tape</p> |
|---|---|

■ List of Models

Model	Plunger type	Operating force (OF)	Bag (see note 1)	Embossed tape (see note 2)
6 x 6 mm B3FS-1000 Series	Flat type 	Standard model 0.98 N {100 gf}	B3FS-1000	B3FS-1000P
		High-force 1.47 N {150 gf}	B3FS-1002	B3FS-1002P

- Note:**
1. Orders must be made in units of 100 pieces.
 2. Orders must be made in units of 3,000 pieces. For the packing style, refer to *Key Switch Packing* on page 4.

Specifications

■ Ratings/Characteristics

Switching capacity	50 mA, 24 VDC (resistive load)
Insulation voltage	30 VDC
Contact configuration	SPST-NO
Contact material	Silver plating
Contact resistance	100 mΩ max. (initial value) (rated: 1 mA, 5 VDC)
Insulation resistance	100 MΩ min. (at 100 VDC)
Dielectric strength	250 VAC, 50/60 Hz for 1 min
Bounce time	5 ms max.
Vibration resistance	Malfunction: 10 to 55 Hz, 1.5-mm double amplitude
Shock resistance	Destruction: 1,000 m/s ² min. {approx. 100G min.} Malfunction: 100 m/s ² min. {approx. 10G min.}
Life expectancy	Standard models: 1,000,000 operations min. High-force models: 300,000 operations min.
Ambient temperature	Operating: -40°C to 85°C (with no icing)
Ambient humidity	Operating: 35% to 85%
Weight	Approx. 0.2 g

Engineering Data

Operating Force vs. Stroke Characteristics

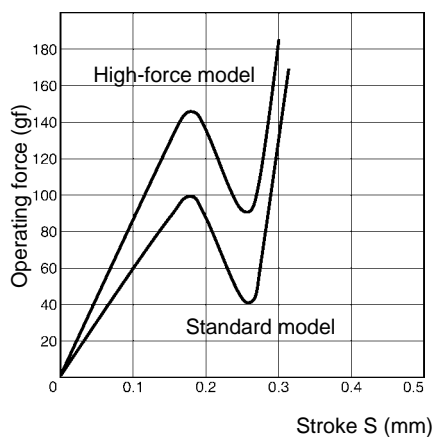

Dimensions

Note: All units are in millimeters unless otherwise indicated. Unless otherwise specified, a tolerance of ± 0.4 mm applies to all dimensions.

B3FS-1000
B3FS-1002
B3FS-1000P
B3FS-1002P

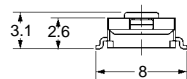
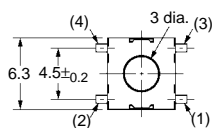

PCB Pad
 (Top View)
 (One-side PCB t = 1.6)

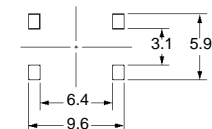

**Terminal Arrangement/
 Internal Connection**
 (Top View)

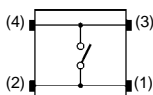

Operating Characteristics

Item	B3FS-1000 Series	
	Standard model	High-force model
Operating force (OF)	0.98±0.29 N {100±30 gf}	1.47±0.49 N {150±50 gf}
Releasing force (RF)	0.2 N min. {20 gf}	0.49 N min. {50 gf}
Pretravel (PT)	0.25 ^{+0.2} _{-0.1} mm	

Precautions

Operation

Do not repeatedly operate the Switch with high force, apply additional force to the plunger once it has stopped moving, or operate the Switch with excessive force, otherwise the disc spring of the Switch may deform and the Switch may malfunction.

Be sure to set the Switch so that the plunger will be pressed straight. A decrease in the life of the Switch may result if the plunger is pressed off-center or from an acute angle.



The Switch is not of enclosed construction. Be sure to protect the Switch with an appropriate sheet when using the Switch in locations with excessive dust.

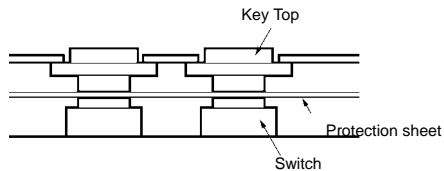

Soldering

Do not apply flow soldering, otherwise fragments of solder and flux may have a bad influence on the operation of the pushbutton.

Apply reflow soldering according to the optimum heating curve shown below. Reflow soldering equipment may have a high peak value. Be sure to conduct a test before use.

Soldering may be repeated only once at a minimum interval of five minutes if the Switch is not soldered properly.

No flux can be wiped or cleaned after soldering the Switch because the cleaning solvent will penetrate into the interior of the Switch together with the flux and dust on the PCB. As a result, the Switch may malfunction.

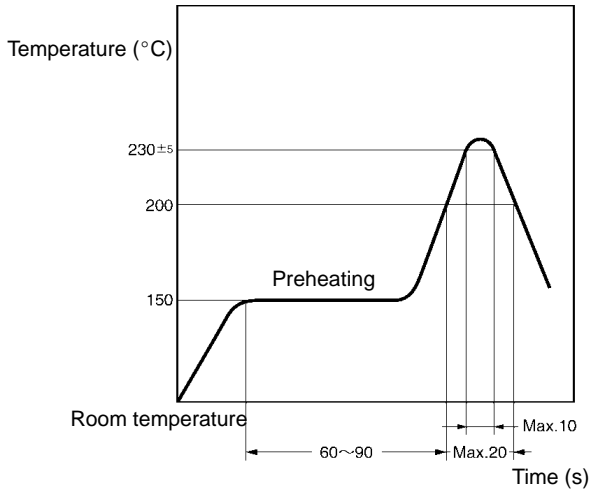

Note: The above curve is given on condition that the thickness of the PCB is 1.6 mm.

Key Switch Packing

Key Switches are packed on tape as shown below.

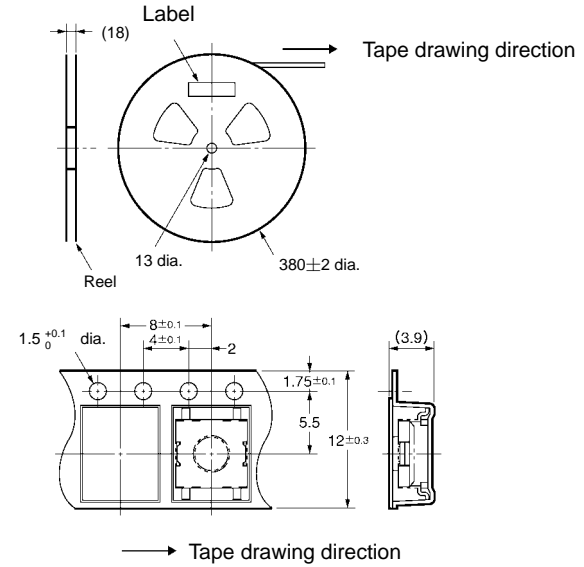

Standard	Conform to EIAJ standards
Package	3,000 Switches
Heat resistance	50°C for 24 hours (not be deformed)

ALL DIMENSIONS SHOWN ARE IN MILLIMETERS.
 To convert millimeters into inches, multiply by 0.03937. To convert grams into ounces, multiply by 0.03527.

Cat. No. A113-E1-1 **In the interest of product improvement, specifications are subject to change without notice.**

OMRON Corporation

C&C Components Division H.Q.
 Mechanical-Components Division
 28th Fl., Crystal Tower Bldg.,
 1-2-27, Shiromi, Chuo-ku,
 Osaka 540-6028 Japan
 Phone: (81)6-949-6017 Fax: (81)6-949-6134

Printed in Japan
 1098-1M (1098) Ⓐ