

## Miniature Basic Switch

# V

### Reliable and Safe Basic Switch

- Best seller series with switching currents of 10 to 21 A.
- Applications include not only industrial equipment but also commercial products (OEM).
- Available in two types of cases: thermoplastic resin and thermosetting resin.

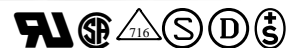







## Ordering Information

Consult OMRON for standard approvals of models.



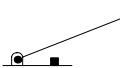



### ■ Ordering Information

#### General-purpose







#### Thermoplastic Case

Actuator	Contact form	Terminals (see note)	21 A		
			Without barrier	Right-hand barrier	Left-hand barrier
<b>Pin plunger</b> 	SPDT	C	V-21-1C6	V-21-1CR6	V-21-1CL6
	SPST-NC	C	V-21-2C6	V-21-2CR6	V-21-2CL6
	SPST-NO	C	V-21-3C6	V-21-3CR6	V-21-3CL6
<b>Short hinge lever</b> 	SPDT	C	V-211-1C6	---	---
<b>Hinge lever</b> 	SPDT	C	V-212-1C6	---	---
<b>Long hinge lever</b> 	SPDT	C	V-213-1C6	---	---
<b>Simulated hinge lever</b> 	SPDT	C	V-214-1C6	---	---
<b>Short hinge roller lever</b> 	SPDT	C	V-215-1C6	---	---
<b>Hinge roller lever</b> 	SPDT	C	V-216-1C6	---	---

Note: C: Quick-connect terminal (#250)







Actuator	Contact form	Terminals (see note)	16 A		
			Without barrier	Right-hand barrier	Left-hand barrier
<b>Pin plunger</b> 	SPDT	A	V-16-1A5	V-16-1AR5	V-16-1AL5
		C2	V-16-1C25	V-16-1C2R5	V-16-1C2L5
		C	V-16-1C5	---	---
	SPST-NC	A	V-16-2A5	V-16-2AR5	V-16-2AL5
		C2	V-16-2C25	V-16-2C2R5	V-16-2C2L5
		C	V-16-2C5	---	---
	SPST-NO	A	V-16-3A5	V-16-3AR5	V-16-3AL5
		C2	V-16-3C25	V-16-3C2R5	V-16-3C2L5
		C	V-16-3C5	---	---
<b>Short hinge lever</b> 	SPDT	A	V-161-1A5	---	---
		C2	V-161-1C25	---	---
		C	V-161-1C5	---	---
<b>Hinge lever</b> 	SPDT	A	V-162-1A5	---	---
		C2	V-162-1C25	---	---
		C	V-162-1C5	---	---
<b>Long hinge lever</b> 	SPDT	A	V-163-1A5	---	---
		C2	V-163-1C25	---	---
		C	V-163-1C5	---	---
<b>Simulated hinge lever</b> 	SPDT	A	V-164-1A5	---	---
		C2	V-164-1C25	---	---
		C	V-164-1C5	---	---
<b>Short hinge roller lever</b> 	SPDT	A	V-165-1A5	---	---
		C2	V-165-1C25	---	---
		C	V-165-1C5	---	---
<b>Hinge roller lever</b> 	SPDT	A	V-166-1A5	---	---
		C2	V-166-1C25	---	---
		C	V-166-1C5	---	---

**Note:** A: Solder/quick-connect terminal (#187)  
 C2: Quick-connect terminal (#187)  
 C: Quick-connect terminal (#250)

Actuator	Contact form	Terminals (see note)	11 A
Pin plunger 	SPDT	A	V-11-1A4
		C2	V-11-1C24
		C	V-11-1C4
Short hinge lever 	SPDT	A	V-111-1A4
		C2	V-111-1C24
		C	V-111-1C4
Hinge lever 	SPDT	A	V-112-1A4
		C2	V-112-1C24
		C	V-112-1C4
Long hinge lever 	SPDT	A	V-113-1A4
		C2	V-113-1C24
		C	V-113-1C4
Simulated hinge lever 	SPDT	A	V-114-1A4
		C2	V-114-1C24
		C	V-114-1C4
Short hinge roller lever 	SPDT	A	V-115-1A4
		C2	V-115-1C24
		C	V-115-1C4
Hinge roller lever 	SPDT	A	V-116-1A4
		C2	V-116-1C24
		C	V-116-1C4







**Note:** A: Solder/quick-connect terminal (#187)  
C2: Quick-connect terminal (#187)  
C: Quick-connect terminal (#250)

**Thermosetting Case**

Actuator	Contact form	Terminals (see note)	15 A	10 A	
				OF: 200 gf	OF: 100 gf
<b>Pin plunger</b> 	SPDT	A	V-15-1A5	V-10-1A5	V-10-1A4
		C2	V-15-1C25	V-10-1C25	V-10-1C24
		C	V-15-1C5	---	---
		B	V-15-1B5	V-10-1B5	V-10-1B4
		E	V-15-1E5	V-10-1E5	V-10-1E4
	SPST-NC	A	V-15-2A5	V-10-2A5	V-10-2A4
		C2	V-15-2C25	V-10-2C25	V-10-2C24
		C	V-15-2C5	---	---
	SPST-NO	A	V-15-3A5	V-10-3A5	V-10-3A4
C2		V-15-3C25	V-10-3C25	V-10-3C24	
C		V-15-3C5	---	---	
<b>Short hinge lever</b> 	SPDT	A	V-151-1A5	V-101-1A5	V-101-1A4
		C2	V-151-1C25	V-101-1C25	V-101-1C24
		B	V-151-1B5	V-101-1B5	V-101-1B4
		E	V-151-1E5	V-101-1E5	V-101-1E4
<b>Hinge lever</b> 	SPDT	A	V-152-1A5	V-102-1A5	V-102-1A4
		C2	V-152-1C25	V-102-1C25	V-102-1C24
		B	V-152-1B5	V-102-1B5	V-102-1B4
		E	V-152-1E5	V-102-1E5	V-102-1E4
<b>Long hinge lever</b> 	SPDT	A	V-153-1A5	V-103-1A5	V-103-1A4
		C2	V-153-1C25	V-103-1C25	V-103-1C24
		B	V-153-1B5	V-103-1B5	V-103-1B4
		E	V-153-1E5	V-103-1E5	V-103-1E4
<b>Simulated hinge lever</b> 	SPDT	A	V-154-1A5	V-104-1A5	V-104-1A4
		C2	V-154-1C25	V-104-1C25	V-104-1C24
		B	V-154-1B5	V-104-1B5	V-104-1B4
		E	V-154-1E5	V-104-1E5	V-104-1E4
<b>Short hinge roller lever</b> 	SPDT	A	V-155-1A5	V-105-1A5	V-105-1A4
		C2	V-155-1C25	V-105-1C25	V-105-1C24
		B	V-155-1B5	V-105-1B5	V-105-1B4
		E	V-155-1E5	V-105-1E5	V-105-1E4
<b>Hinge roller lever</b> 	SPDT	A	V-156-1A5	V-106-1A5	V-106-1A4
		C2	V-156-1C25	V-106-1C25	V-106-1C24
		B	V-156-1B5	V-106-1B5	V-106-1B4
		E	V-156-1E5	V-106-1E5	V-106-1E4

**Note:** A: Solder/quick-connect terminal (#187)  
 C2: Quick-connect terminal (#187)  
 C: Quick-connect terminal (#250)  
 B: Screw terminal  
 E: Solder terminal

## Heat Resistant Models

Actuator	15 A	10 A
Pin plunger 	V-15-1A5-T	V-10-1A4-T
Short hinge lever 	V-151-1A5-T	V-101-1A4-T
Hinge lever 	V-152-1A5-T	V-102-1A4-T
Long hinge lever 	V-153-1A5-T	V-103-1A4-T
Simulated hinge lever 	V-154-1A5-T	V-104-1A4-T
Short hinge roller lever 	V-155-1A5-T	V-105-1A4-T
Hinge roller lever 	V-156-1A5-T	V-106-1A4-T

**Note:** Terminals: solder and quick-connect (#187)

### Barrier (V-21 and V-16 Series Only)

Right-hand Barrier

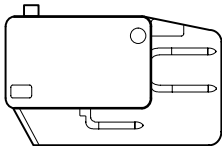

Left-hand Barrier

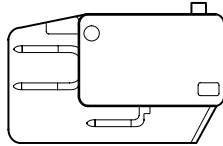

### Model Number Legend

V-□□□-□□□□-□  
1 2 3 4 5 6 7 8

#### 1. Ratings

21: 21 A  
16: 16 A  
15: 15 A  
11: 11 A  
10: 10 A

#### 2. Contact Gap

None: 1 mm (F gap)  
G: 0.5 mm (G gap)

#### 3. Actuator

None: Pin plunger  
1: Short hinge lever  
2: Hinge lever  
3: Long hinge lever  
4: Simulated hinge lever  
5: Short hinge roller lever  
6: Hinge roller lever  
25: Stainless short hinge roller lever  
26: Stainless hinge roller lever

#### 4. Contact Form

1: SPDT  
2: SPST-NC  
3: SPST-NO

#### 5. Terminals

A: Solder/quick-connect terminal (#187)  
C2: Quick-connect terminal (#187)  
C: Quick-connect terminal (#250)  
B: Screw terminal  
E: Solder terminal

#### 6. Barrier (Models with Thermoplastic Case Only)

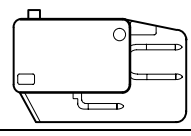
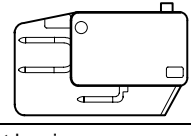
R	Right-hand barrier 
L	Left-hand barrier 
None	Without barrier

#### 7. OF Max. (Pin Plunger)

6: 400 gf  
5: 200 gf  
4: 100 gf

#### 8. Special Purpose

T: Heat-resistive Model  
M: Model with 2.9-inch mounting hole

**■ Combination  
General-purpose**

Classification	Model	Ratings	Terminal					OF max. (pin plunger)			With barrier	Approved standards	
			Shape (see note)					100 gf (0.98 N)	200 gf (1.96 N)	400 gf (3.92 N)			
			A	C2	C	B	E						
Standard model	Thermo-plastic case	V-21	21 A, 250 V			Yes				Yes	Yes	UL, CSA, VDE, SEMKO, DEMKO, SETI, KEMA, NEMKO, SEV	
		V-16	16 A, 250 V	Yes	Yes	Yes			Only upon request	Yes	Only upon request		Yes
		V-11	11 A, 250 V	Yes	Yes	Yes			Yes	Only upon request			
	Thermo-setting case	V-15	15 A, 250 V	Yes	Yes	Yes	Yes	Yes	Only upon request	Yes	Only upon request		UL, CSA
		V-10	10 A, 250 V	Yes	Yes	Yes	Yes	Yes	Yes	Yes			
Special model	Heat resistive	V-□-T	10 and 15 A, 250 V	Yes					Yes	Yes	Only upon request	UL, CSA	
	Inch screw-mount	V-□-K	10 to 21 A, 250 V	Only upon request	Only upon request	Only upon request			Only upon request	Only upon request	Only upon request		

**Note:** A: Solder/quick-connect terminal (#187)  
 C2: Quick-connect terminal (#187)  
 C: Quick-connect terminal (#250)  
 B: Screw terminal  
 E: Solder terminal

**■ Remarks**

**V-series Switch Selection Guide According to Rated Current and OF**

Rated current	OF max. (pin plunger)					
	10 gf	25 gf	50 gf	100 gf	200 gf	400 gf
0.1 A, 1 A	D2MV-01, D2MV-1	VX-01, D2MV-01, D2MV-1	VX-01, D2MV-01, D2MV-1			
5 A		VX-5, K	VX-5			
10 A, 11 A				V-10 (see note 1) V-11	V-10 (see note 1) V-11 (see note 2)	
15 A, 16 A				V-15 (see note 1 and 2) V-16 (see note 2)	V-15 (see note 1) V-16	V-15 (see note 1 and 2) V-16 (see note 2)
21 A						V-21

**Note:** 1. Heat resistive versions of asterisk marked models are available, which resist temperatures up to 150°C.  
 2. These models can be modified.

**Features**

D2MV: Switching ultra-minute loads  
 VX: Highly reliable switching of minute loads  
 K: Switching minute loads  
 V: Switching high currents

# Specifications

## ■ Ratings

Ratings	Rated voltage	Non-inductive load				Inductive load			
		Resistive load		Lamp load		Inductive load		Motor load	
		NC	NO	NC	NO	NC	NO	NC	NO
21 A	250 VAC	21 A		3 A		12 A		4 A	
	8 VDC	21 A		5 A		12 A		7 A	
	30 VDC	14 A		5 A		12 A		5 A	
	125 VDC	0.6 A		0.1 A		0.6 A		0.1 A	
	250 VDC	0.3 A		0.05 A		0.3 A		0.05 A	
16 A	250 VAC	16 A		2 A		10 A		3 A	
	8 VDC	16 A		4 A		10 A		6 A	
	30 VDC	10 A		4 A		10 A		4 A	
	125 VDC	0.6 A		0.1 A		0.6 A		0.1 A	
	250 VDC	0.3 A		0.05 A		0.3 A		0.05 A	
15 A	250 VAC	15 A		2 A		10 A		3 A	
	8 VDC	15 A		4 A		10 A		6 A	
	30 VDC	10 A		4 A		10 A		4 A	
	125 VDC	0.6 A		0.1 A		0.6 A		0.1 A	
	250 VDC	0.3 A		0.05 A		0.3 A		0.05 A	
11 A	250 VAC	11 A		1.5 A		6 A		2 A	
	8 VDC	11 A		3 A		6 A		3 A	
	30 VDC	6 A		3 A		6 A		3 A	
	125 VDC	0.6 A		0.1 A		0.6 A		0.1 A	
	250 VDC	0.3 A		0.05 A		0.3 A		0.05 A	
10 A	250 VAC	10 A		1.5 A		6 A		2 A	
	8 VDC	10 A		3 A		6 A		3 A	
	30 VDC	6 A		3 A		6 A		3 A	
	125 VDC	0.6 A		0.1 A		0.6 A		0.1 A	
	250 VDC	0.3 A		0.05 A		0.3 A		0.05 A	

- Note:**
- The above current values are the normal current values of models with a contact gap of 1 mm (gap F), which vary with the normal current values of models with a contact gap of 0.5 mm (gap G).
  - Inductive load has a power factor of 0.4 min. (AC) and a time constant of 7 ms max. (DC).
  - Lamp load has an inrush current of 10 times the steady-state current.
  - Motor load has an inrush current of 6 times the steady-state current.

## Contact Form

SPDT

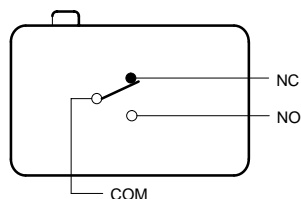

SPST-NC

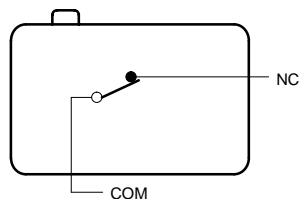

SPST-NO

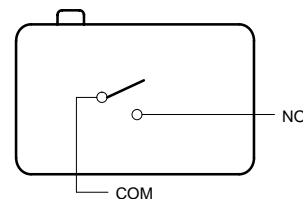

■ Characteristics

Operating speed	0.1 mm to 1 m/s (at pin plunger)
Operating frequency	Mechanical: 600 operations/min Electrical: 60 operations/min
Insulation resistance	100 MΩ min. (at 500 VDC)
Contact resistance	15 mΩ max. (initial value)
Inrush current (NC/NO)	V-21: 50 A max., V-16: 40 A max., V-15: 36 A max., V-11: 24 V max., V-10: 24 A max.
Dielectric strength	1,000 VAC, 50/60 Hz for 1 min between non-continuous terminals 2,000 VAC (1,500 VAC for V-15 and V-10), 50/60 Hz for 1 min between each terminal and ground
Vibration resistance	Malfunction: 10 to 55 Hz, 1.5-mm double amplitude
Shock resistance	Mechanical: 1,000 m/s <sup>2</sup> min. (approx. 100G min.) Malfunction: V-21/V-16/V-15: 300 m/s <sup>2</sup> (approx. 30G min.) V-11/V-10: 200 m/s <sup>2</sup> (approx. 20G min.)
Life expectancy	Mechanical: 50,000,000 operations min. Electrical: V-21/V-16/V-15: 100,000 operations min. V-11/V-10: 300,000 operations min.
Ambient temperature	Operating: -25°C to 80°C (with no icing) -25°C to 150°C for heat-resistive model
Ambient humidity	Operating: 85% max.
Contact	Specifications: Rivet Materials: V-21/V-16/V-15: Silver alloy V-11/V-10: Silver
Weight	Approx. 6.2 g

Note: The operating speed value shown is for pin plunger models. For hinge lever models, this speed is for the plunger parts.

■ Approved Standards

UL (File No. E32667)/CSA (File No. LR21642)/  
VDE (File No. 716)/SEMKO (File No. 9114062)

■ Operating Characteristics

Thermoplastic Case

Model	Pin plunger			Short hinge lever		
	V-21-1□6	V-16-1□5	V-11-1□4	V-211-1□6	V-161-1□5	V-111-1□4
OF max.	3.92 N (400 gf)	1.96 N (200 gf)	0.98 N (100 gf)	3.92 N (400 gf)	1.96 N (200 gf)	0.98 N (100 gf)
RF min.	0.78 N (80 gf)	0.49 N (50 gf)	0.20 N (20 gf)	0.49 N (50 gf)	0.49 N (50 gf)	0.15 N (15 gf)
PT max.	1.2 mm			1.6 mm		
OT min.	1.0 mm			0.8 mm		
MD max.	0.4 (0.3) mm (see note)			0.6 (0.5) mm (see note)		
OP	14.7±0.4 mm			15.2±0.5 mm		

Model	Hinge lever			Long hinge lever		
	V-212-1□6	V-162-1□5	V-112-1□4	V-213-1□6	V-163-1□5	V-113-1□4
OF max.	2.45 N (250 gf)	1.23 N (125 gf)	0.59 N (60 gf)	1.27 N (130 gf)	0.69 N (70 gf)	0.34 N (35 gf)
RF min.	0.25 N (25 gf)	0.14 N (14 gf)	0.06 N (6 gf)	0.12 N (12 gf)	0.06 N (6 gf)	---
PT max.	4.0 mm			9.0 mm		
OT min.	1.6 mm			2.0 mm		
MD max.	1.5 (0.8) mm (see note)			2.8 (2.0) mm (see note)		
OP	15.2±1.2 mm			15.2 <sup>+2.6</sup> / <sub>-3.2</sub> mm		15.2±2.6 mm

Model	Simulated hinge lever			Short hinge roller lever		
	V-214-1□6	V-164-1□5	V-114-1□4	V-215-1□6	V-165-1□5	V-115-1□4
OF max.	2.45 N (250 gf)	1.23 N (125 gf)	0.59 N (60 gf)	4.71 N (480 gf)	2.35 N (240 gf)	1.18 N (120 gf)
RF min.	0.25 N (25 gf)	0.14 N (14 gf)	0.06 N (6 gf)	0.49 N (50 gf)	0.49 N (50 gf)	0.15 N (15 gf)
PT max.	4.0 mm			1.6 mm		
OT min.	1.6 mm			0.8 mm		
MD max.	1.5 (0.8) mm (see note)			0.6 (0.5) mm (see note)		
OP	18.7±1.2 mm			20.7±0.6 mm		

Note: The value in the parentheses indicates the G gap.

Model	Hinge roller lever		
	V-216-1□6	V-166-1□5	V-116-1□4
OF max.	2.45 N (250 gf)	1.23 N (125 gf)	0.59 N (60 gf)
RF min.	0.25 N (25 gf)	0.14 N (14 gf)	0.06 N (6 gf)
PT max.	4.0 mm		
OT min.	1.6 mm		
MD max.	1.5 (0.8) mm (see note)		
OP	20.7±1.2 mm		

Note: The value in the parentheses indicates the G gap.

### Thermoplastic Case (V-15/-10 Models)

Model	Pin plunger		Short hinge lever		Hinge lever	
	V-15-1□5 V-10-1□5	V-10-1□4	V-151-1□5 V-101-1□5	V-101-1□4	V-152-1□5 V-102-1□5	V-102-1□4
OF max.	1.96 N (200 gf)	0.98 N (100 gf)	1.96 N (200 gf)	0.98 N (100 gf)	1.23 N (125 gf)	0.59 N (60 gf)
RF min.	0.49 N (50 gf)	0.20 N (20 gf)	0.49 N (50 gf)	0.15 N (15 gf)	0.14 N (14 gf)	0.06 N (6 gf)
PT max.	1.2 mm		1.6 mm		4 mm	
OT min.	1.0 mm		0.8 mm		1.6 mm	
MD max.	0.4 (0.3) mm (see note)		0.6 (0.5) mm (see note)		1.5 (0.8) mm (see note)	
OP	14.7±0.4 mm		15.2±0.5 mm		15.2±1.2 mm	

Model	Long hinge lever		Simulated hinge lever		Short hinge roller lever	
	V-153-1□5 V-103-1□5	V-103-1□4	V-154-1□5 V-104-1□5	V-104-1□4	V-155-1□5 V-105-1□5	V-105-1□4
OF max.	0.69 N (70 gf)	0.34 N (35 gf)	1.23 N (125 gf)	0.59 N (60 gf)	2.35 N (240 gf)	1.18 N (120 gf)
RF min.	0.06 N (6 gf)	---	0.14 N (14 gf)	0.06 N (6 gf)	0.49 N (50 gf)	0.15 N (15 gf)
PT max.	9.0 mm		4.0 mm		1.6 mm	
OT min.	2.0 mm		1.6 mm		0.8 mm	
MD max.	2.8 (2.0) mm (see note)		1.5 (0.8) mm (see note)		0.6 (0.5) mm (see note)	
OP	15.2 <sup>+2.6</sup> / <sub>-3.2</sub> mm	15.2±2.6 mm	18.7±1.2 mm		20.7±0.6 mm	

Model	Hinge roller lever	
	V-156-1□5 V-106-1□5	V-106-1□4
OF max.	1.23 N (125 gf)	0.59 N (60 gf)
RF min.	0.14 N (14 gf)	0.06 N (6 gf)
PT max.	4.0 mm	
OT min.	1.6 mm	
MD max.	1.5 (0.8) mm (see note)	
OP	20.7±1.2 mm	

Note: The value in the parentheses indicates the G gap.

# Engineering Data

## Mechanical Life Expectancy

V-21/-16/-15/-11/-10

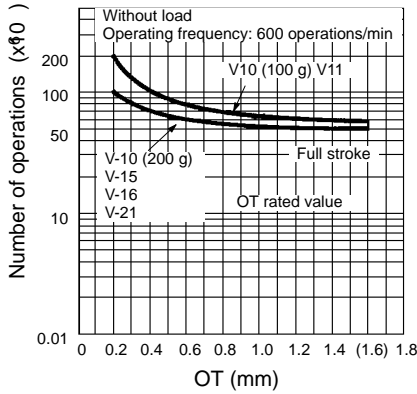

## Electrical Life Expectancy

V-21/-16/-15

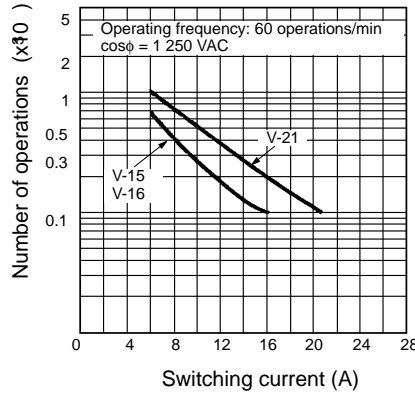

V-11/-10

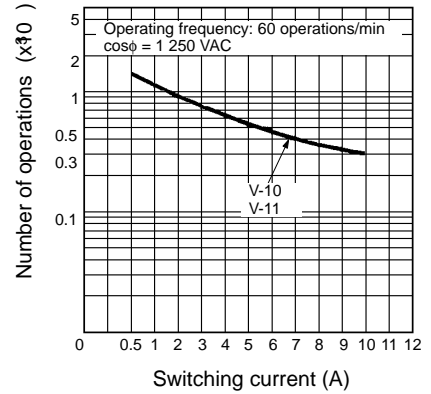

# Dimensions

**Note:** 1. All units are in millimeters unless otherwise indicated.

2. Unless otherwise specified, a tolerance of ±0.4 mm applies to all dimensions.

3. The following illustrations and drawings are for #250-series models with tab terminals (terminals C). V models with a switching current of 16 A or 11 A incorporates terminals A and C2. These models are different from #250-series models in terminal size only. Terminals A, C2, and side terminals are omitted from the following drawings. Refer to *Kinds of "Terminals"* on page 72 for these terminals.

### Pin Plunger

(Without Barrier)

V-21-1□6

V-16-1□5

V-11-1□4

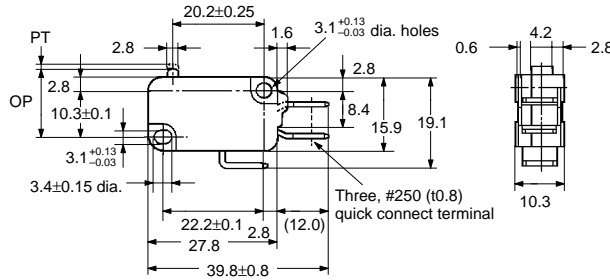
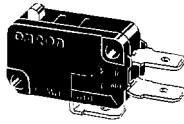

(With Right-hand Barrier)

V-21-1□R6

V-16-1□R5

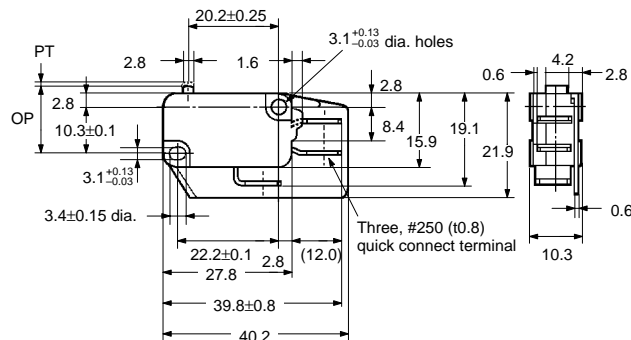
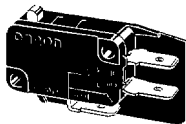

(With Left-hand Barrier)

- V-21-1□L6
- V-16-1□L5

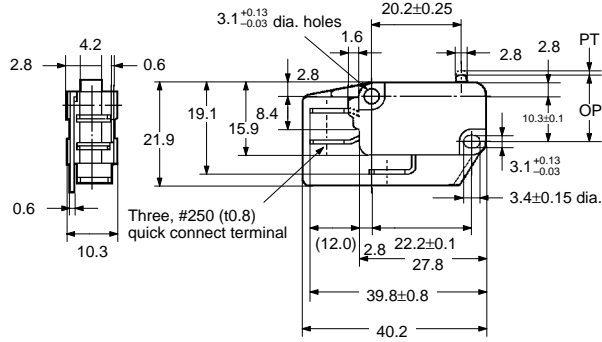
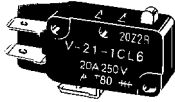

Short Hinge Lever

- V-211-1□6
- V-161-1□5
- V-111-1□4

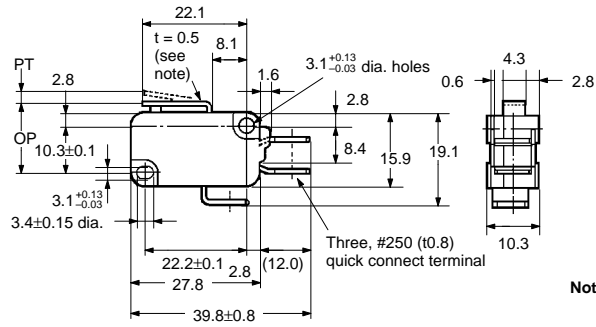
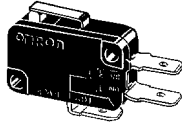

Note: Stainless steel lever

Hinge Lever

- V-212-1□6
- V-162-1□5
- V-112-1□4

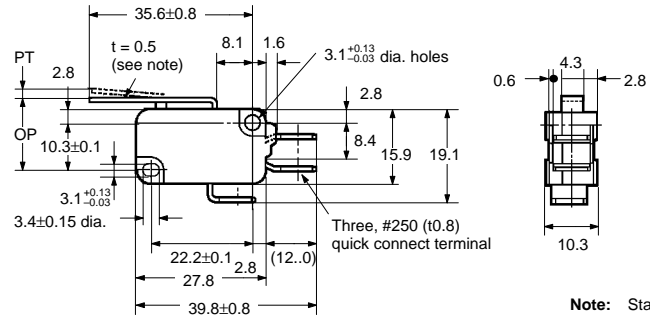
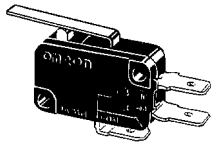

Note: Stainless steel lever

Long Hinge Lever

- V-213-1□6
- V-163-1□5
- V-113-1□4

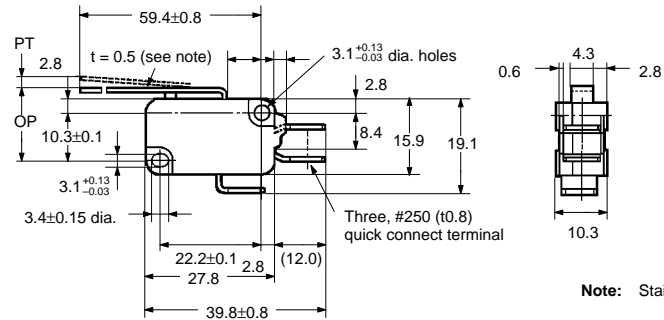
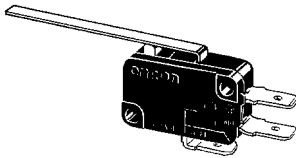

Note: Stainless steel lever

Simulated Hinge Lever

- V-214-1□6
- V-164-1□5
- V-114-1□4

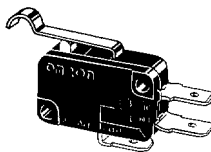

Note: Stainless steel lever

**Short Hinge Roller Lever**

- V-215-1□6
- V-165-1□5
- V-115-1□4

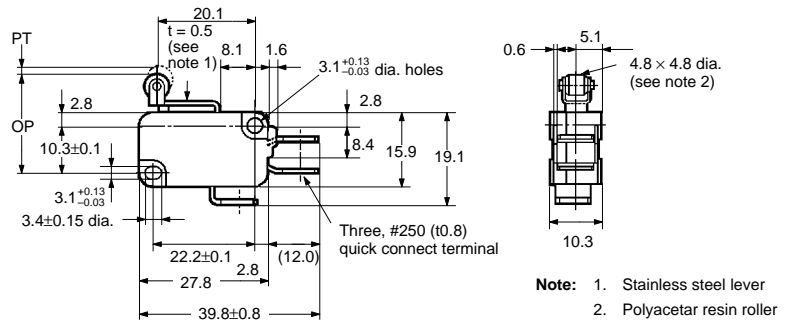
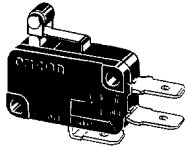

**Hinge Roller Lever**

- V-216-1□6
- V-166-1□5
- V-116-1□4

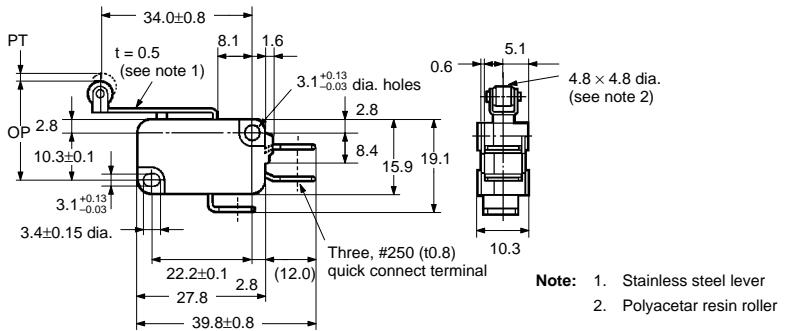
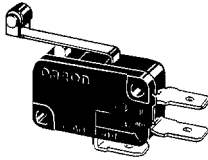

**Thermoplastic Case (V-15/-10 Models)**

The following illustration and drawing are for #187-series models with solder and tab terminals (terminals A). V models with a switching current of 15 A or 10 A incorporates terminals B, C2, and E. These models are different from #250-series models in terminal size only. Terminals B, C2, E, and side terminals are omitted from the following drawing. Refer to page 72 for these terminals.

**Pin Plunger**

- V-15-1□5
- V-10-1□5
- V-10-1□4

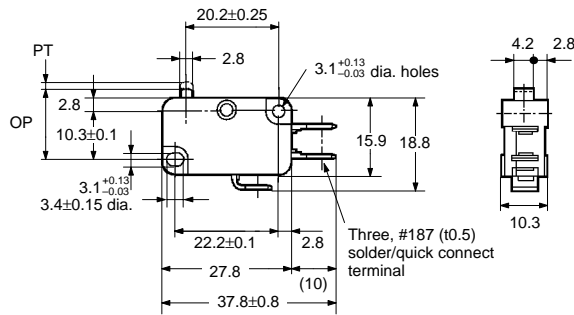
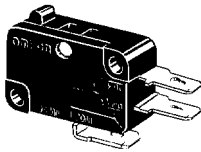

**Short Hinge Lever**

- V-151-1□5
- V-101-1□5
- V-101-1□4

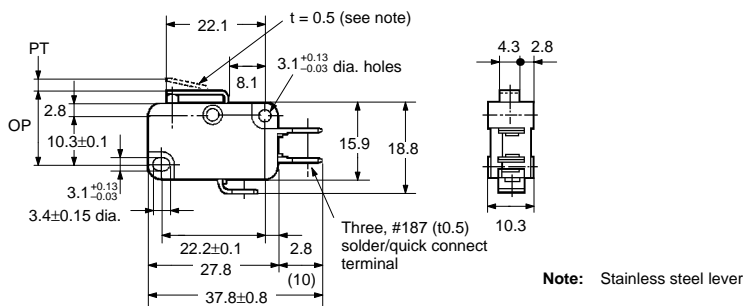
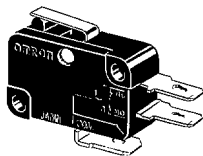

**Hinge Lever**

- V-152-1□5
- V-102-1□5
- V-102-1□4

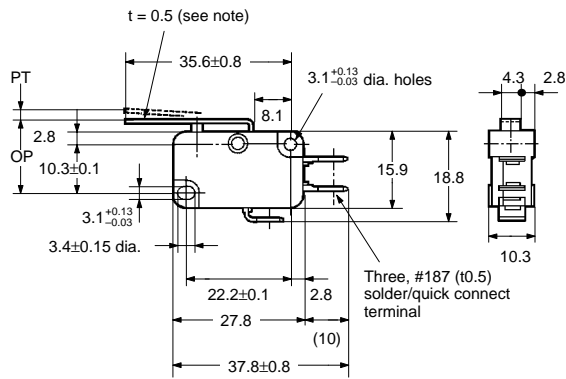
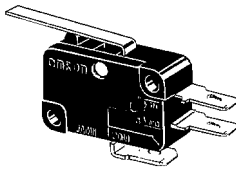

**Note:** Stainless steel lever

**Long Hinge Lever**

- V-153-1□5
- V-103-1□5
- V-103-1□4

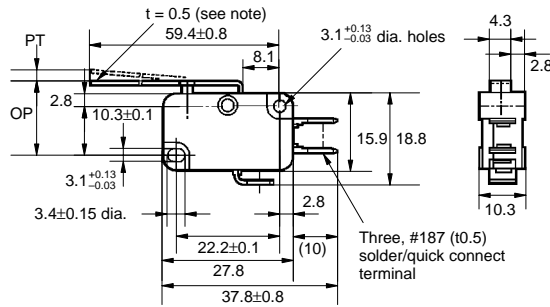
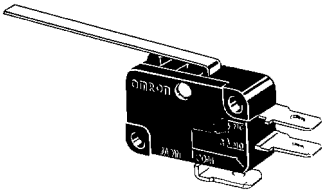

**Note:** Stainless steel lever

**Simulated Hinge Lever**

- V-154-1□5
- V-104-1□5
- V-104-1□4

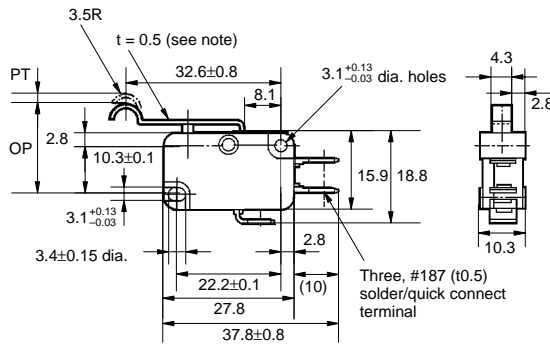
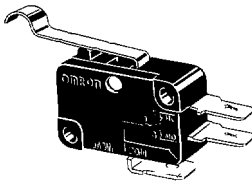

**Note:** Stainless steel lever

**Short Hinge Roller Lever**

- V-155-1□5
- V-105-1□5
- V-105-1□4

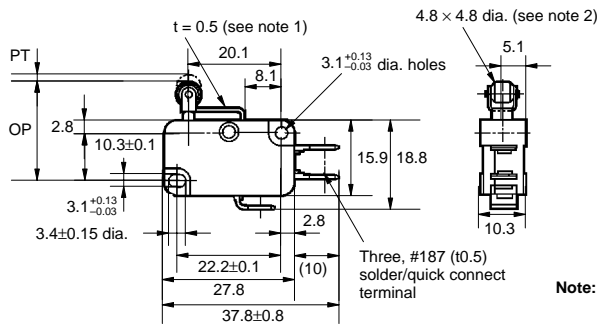
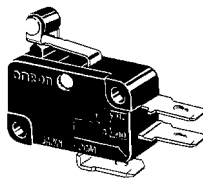

**Note:** 1. Stainless steel lever  
2. Polyacetal resin roller

**Hinge Roller Lever**

- V-156-1□5
- V-106-1□5
- V-106-1□4

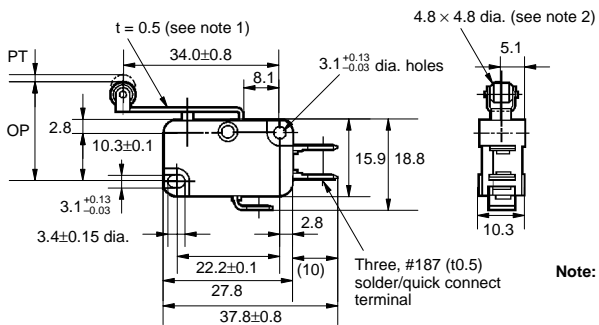
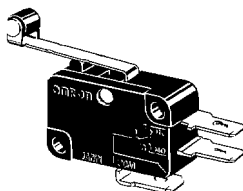

**Note:** 1. Stainless steel lever  
2. Polyacetal resin roller

■ **Terminals**

**Solder/Quick-connect (#187) Terminal (A)**

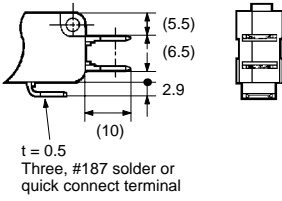

**Quick-connect (#187) Terminal (C2)**

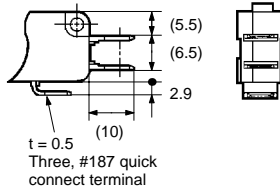

**Quick-connect (#250) Terminal (C)**

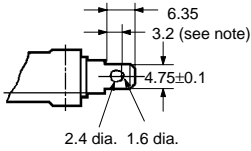
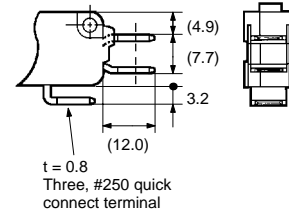

**Note:** Indicates the length to the center of the 1.6 dia. holes

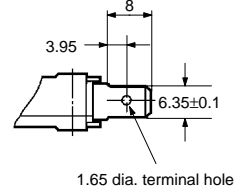
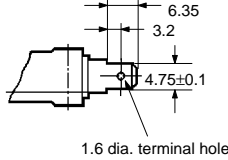

**Bottom Terminal**  
**Solder Terminal (E)**

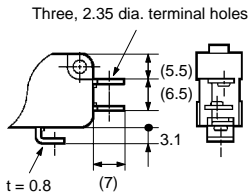

**Screw Terminal (B)**

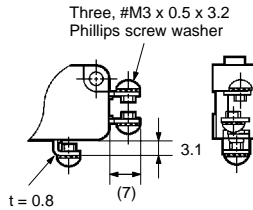

**Precautions**

**Mounting**

Use two M3 mounting screws with an appropriate screwdriver to mount the switch. Tighten the screws to a torque of 4 to 6 kg • cm (0.39 to 0.59 N • m).

**Mounting Holes**

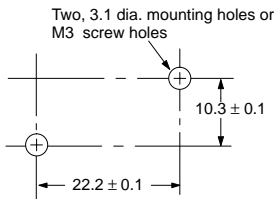

When soldering a lead wire to a terminal of the V, use a soldering iron with a maximum capacity of 60 W and do not take more than 5 s to solder the lead wire, otherwise the characteristics of the V may be altered.

**Operation**

Install the pin plunger switch so that the operating force is applied in alignment with the stroke of the actuator. The switch should be set so that its stroke is in the range of 60 to 90% of the rated OT (minimum value) when the switch has been operated.

**Separator**

When mounting a switch, check the insulation distance between the switch and the mounting plate. If the distance is not enough, mount the switch with an insulation guard or separator or use a switch that incorporates an insulation guard. Especially, when mounting a switch to a metal object, be sure to use an insulation guard or separator.

## ■ Connector

If the user has difficulty using a conventional connector due to the following reasons, use of AMP's Positive Lock Connector or Nippon Tanshi's Firm Lock Connector are recommended.

- Difficult to conduct work due to large insertion force.
- Damage to the switch results due to large insertion force.
- The connector is disconnected with ease when the wires are pulled.

### Nippon Tanshi's Firm Lock Connector

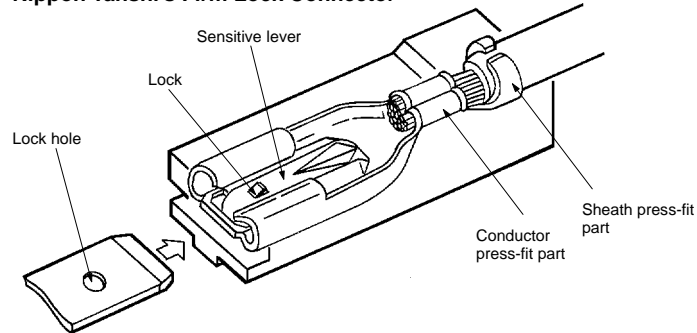

### Lock Mechanism (Nippon Tanshi's Firm Lock Connector)

#### Insertion

The sensitive lever goes down when the tab is inserted.

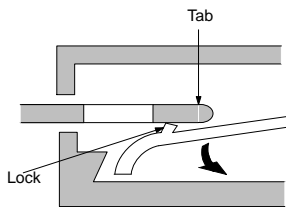

#### Locked

After the tab is inserted, the sensitive lever returns to the previous position and the tab is locked.

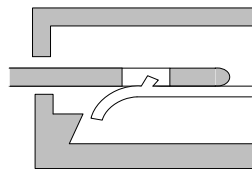

#### Extraction

Hold the housing and pull the tab so that the tip of the sensitive lever touches the slant wall and the tab is unlocked.

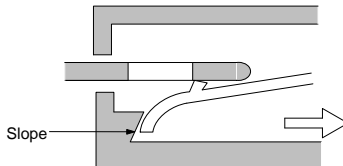

#### Extraction Completed

After the tab is extracted, the sensitive lever returns to the normal position due to the spring force of the sensitive lever.

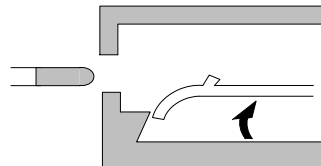

**ALL DIMENSIONS SHOWN ARE IN MILLIMETERS.**

To convert millimeters into inches, multiply by 0.03937. To convert grams into ounces, multiply by 0.03527.