

Cylindrical 8-dia. Indicator

- Same basic design as the A3D Pushbutton Switch.
- Good illumination with even surface brightness.
- Cylindrical body means panel cutouts can be made easily.



Ordering Information

■ Model Number Legend:

The model numbers used to order sets of Units are illustrated below. One set comprises the Display (LED lamp built-in) and Socket Unit.

(1) **M 2 D J** - 9 0 (2) **A 1** - 0 0 (3) **E R**

(1) Shape of Display

Symbol	Shape
J	Rectangular
A	Square
T	Round

(2) Terminal Type

Symbol	Terminal type
A	Solder terminals

If PCB terminals are required, use the Socket given under *Accessories* on page 19.



(3) Color of Display

Symbol	Color
R	Red
Y	Yellow
G	Green
W	White

All models are illumination-only. Colored-illumination models are not available.

An external resistor is required. (Refer to page 25.)

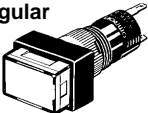
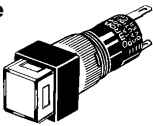
■ List of Models

Appearance	Model
 Rectangular	M2DJ
 Square	M2DA
 Round	M2DT

■ Ordering as a Set

The model numbers used to order sets of Units are given in the following table. One set comprises the Display (LED lamp built-in), and Socket Unit.

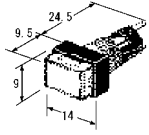
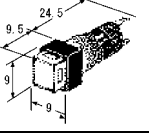
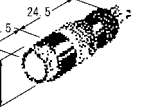
Appearance	Degree of protection	Model number	Color symbol for Display
Rectangular 	IP40	M2DJ-90A1-00E□	R, Y, G, W
Square 		M2DA-90A1-00E□	
Round 		M2DT-90A1-00E□	

Note: 1. Enter the desired color symbol for the Display in □: R (red), Y (yellow), G (green), or W (white)
 2. Degree of protection: IP40

■ Ordering Individually

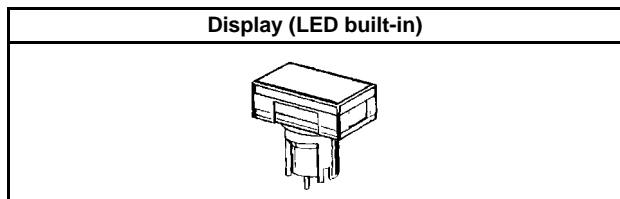

Displays and Socket Units can be ordered separately. Combinations that are not available as sets can be created using individual Units. Also, store the parts as spares for maintenance and repairs.

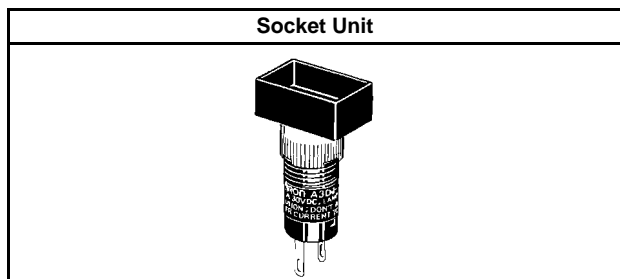

Note: Degree of protection: IP40



■ Display (All Lighted with LED Built-in)

Appearance	Rectangular	Square	Round
Color			
Red	M2DJ-500R	M2DA-500R	M2DT-500R
Yellow	M2DJ-500Y	M2DA-500Y	M2DT-500Y
Green	M2DJ-500GY	M2DA-500GY	M2DT-500GY
White	M2DJ-500W	M2DA-500W	M2DT-500W

Socket Unit

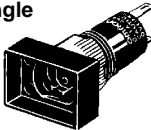
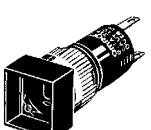
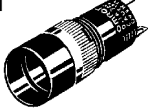
Sealing Appearance	IP40		
	Rectangle	Square	Round
Terminal type			
Solder terminals	M2DJ-7001	M2DA-7001	M2DT-7001

■ Accessories

The accessories for the A3D Lighted Pushbutton Switch can also be used with the M2D. Refer to page 19.

Specifications

■ Ratings

Built-in LED Lamp

Item		Color		
		Red	Yellow (White) (See note 4.)	Green
Forward voltage, V_F	Reference value (See note 3.)	1.7 V	2.2 V	1.7 V
	Maximum value	2.0 V	2.5 V	2.0 V
Forward current, I_F	Reference value	20 mA	20 mA	20 mA
	Absolute maximum value	50 mA	50 mA	50 mA
Permissible dissipation, PD	Absolute maximum value	100 mW	125 mW	122 mW
Reverse voltage, V_R	Absolute maximum value	4 mW	4 mW	4 mW

- Note:**
1. The above ratings are for an ambient temperature of 25°C.
 2. The built-in LED lamp has no limiting resistor and so it is necessary to connect an external resistor within the range shown in the above table. (For details of calculation formulas, refer to page 25.)
 3. Refer to the characteristic graph of $V_F - I_F$ on page 21.
 4. The same LED lamp is used for both yellow illumination and white illumination and so the ratings are the same.

■ Characteristics

Ambient operating temperature	-10°C to 55°C (with no icing or condensation)
Ambient operating humidity	35% to 85%
Ambient storage temperature	-25°C to 65°C

Nomenclature

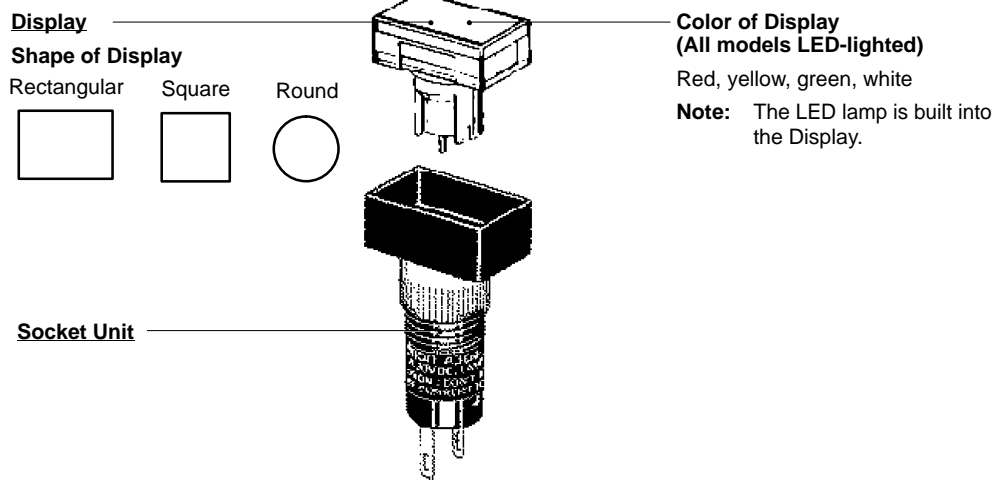
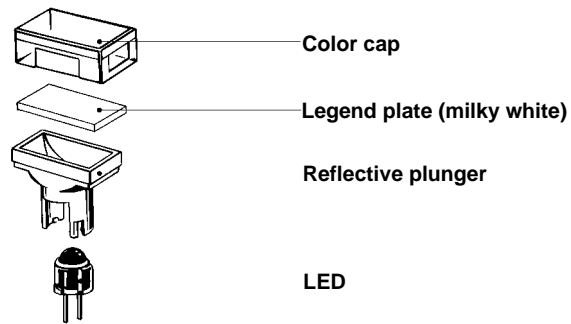

Note: The M2DJ model is shown here as a representative example.

Dimensions

Note: All units are in millimeters unless otherwise indicated.

Rectangular Models (M2DJ-90A1-00E□)

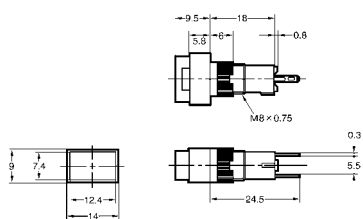

Square Models (M2DA-90A1-00E□)

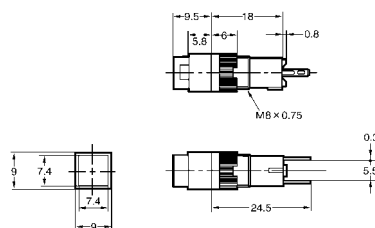

Square Models (M2DT-90A1-00E□)

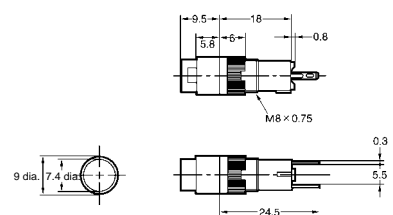

Note: Unless specified, there is a tolerance of ± 0.4 mm for dimensions.

■ Terminals

Solder Terminals

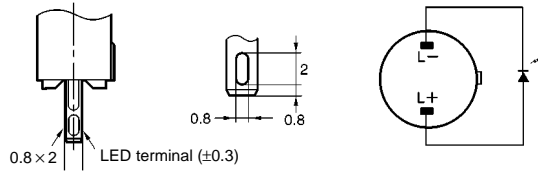

■ Panel Cutouts (Top View)

Rectangular models (M2DJ)	Square models (M2DA) and round models (M2DT)
<p>Note: Recommended panel thickness: 1.0 to 3.2 mm.</p>	<p>Note: Recommended panel thickness: 1.0 to 3.2 mm.</p>

Note: If the panel is to be finished (e.g., coated), make sure that the panel meets the specified dimensions after the coating.

Precautions

■ Correct Use

Refer to the *Common Precautions* for Pushbutton Switches on page 11.

Refer to *Correct Use* for A3D on page 25.

ALL DIMENSIONS SHOWN ARE IN MILLIMETERS.

To convert millimeters into inches, multiply by 0.03937. To convert grams into ounces, multiply by 0.03527.