

22-dia. and 25-dia. Round Indicator Series

- Easy mounting and removal of Socket Unit.
- Use 25-dia. ring to install in 25-dia. panel cutouts.
- Finger protection mechanism on Lamp provided as a standard feature.

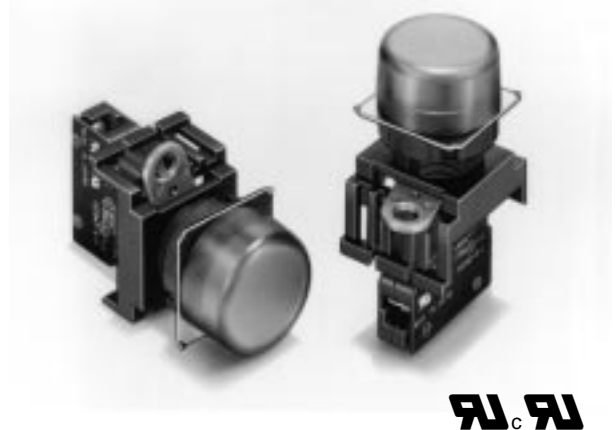

This product was manufactured at OMRON Izumo. OMRON Izumo has obtained approvals from international certification bodies for its quality system and environmental control system.

Ordering Information

■ Model Number Legend (Completely Assembled)

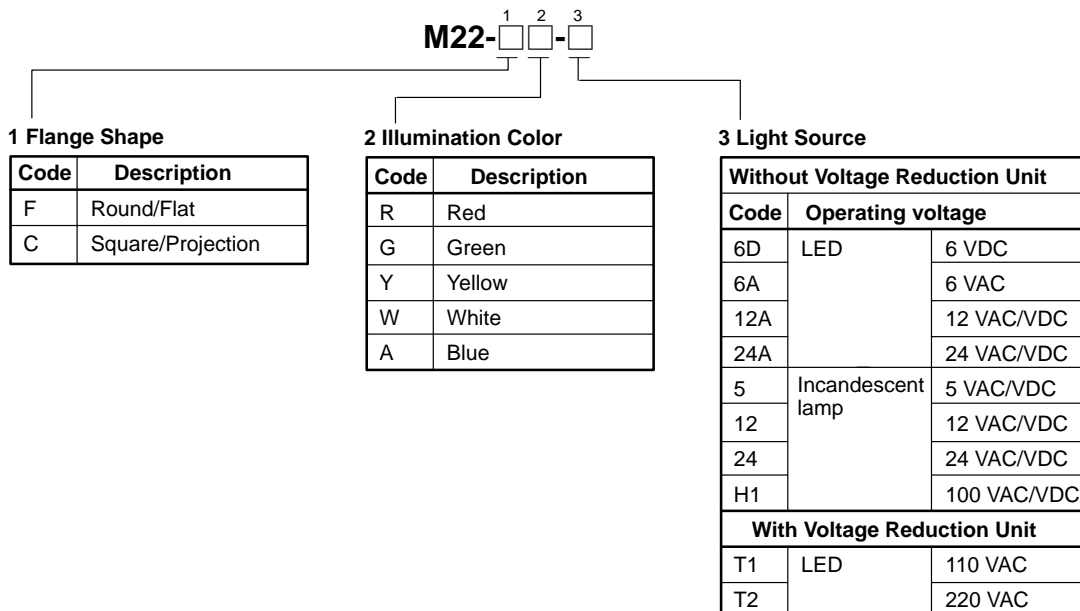

Shipped as a set which includes the Display, Lamp, and Socket Unit.



Note: The LED lamp (24 VAC/VDC) can be lit by directly applying 110 VAC/VDC (220 VAC/VDC) to the lamp terminal. LED incorporates the 24-VAC/VDC type.

■ M22 Indicator (Completely Assembled)

Indicator

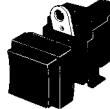
Appearance	Lighting	Rated voltage	Model	Illumination color
Round/Flat without Voltage Reduction Unit  M22-F	LED	6 VDC	M22-F□-6D	Insert one of the following letters into the box □. R (red) Y (yellow) G (green) W (white) A (blue)
		6 VAC	M22-F□-6A	
		12 VAC/DC	M22-F□-12A	
		24 VAC/DC	M22-F□-24A	
Round/Flat with Voltage Reduction Unit  M22-F		110 VAC	M22-F□-T1	
		220 VAC	M22-F□-T2	
Square/Projection without Voltage Reduction Unit  M22-C		6 VDC	M22-C□-6D	
		6 VAC	M22-C□-6A	
	12 VAC/DC	M22-C□-12A		
	24 VAC/DC	M22-C□-24A		
Square/Projection with Voltage Reduction Unit  M22-C	110 VAC	M22-C□-T1		
	220 VAC	M22-C□-T2		

■ Model Number Legend (Subassembly)

The Display, Lamp, or Socket Unit can be ordered separately. Use them in combination for models that are not available as assembled Units. These can also be used as inventory for maintenance parts.

Unit Combinations

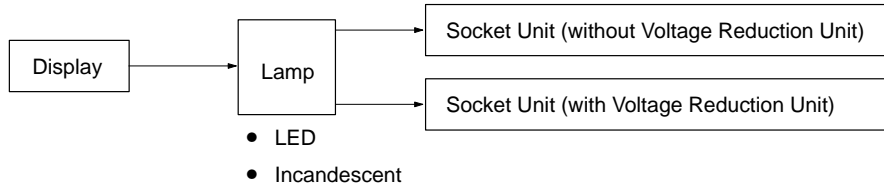

1. Display

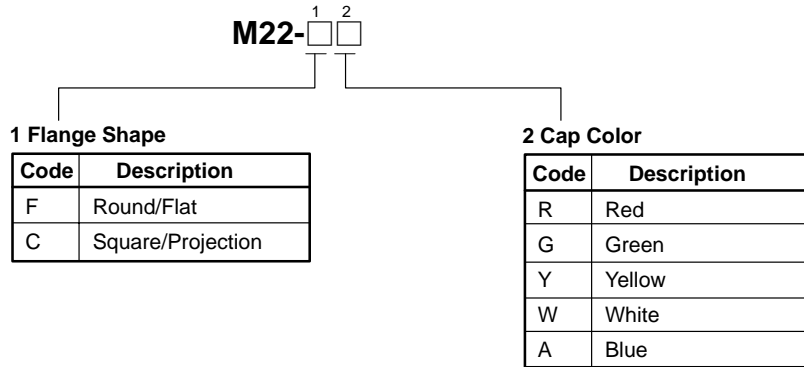

2. Lamp

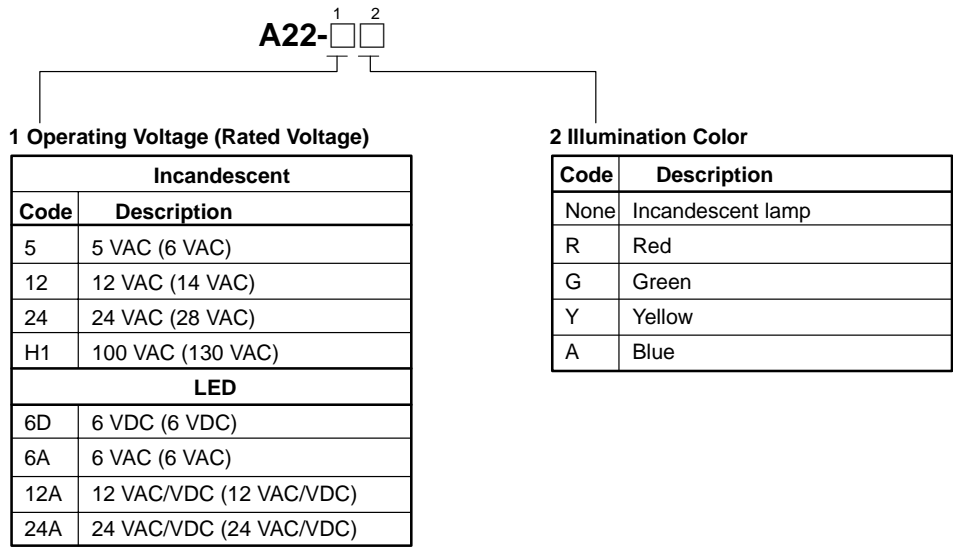

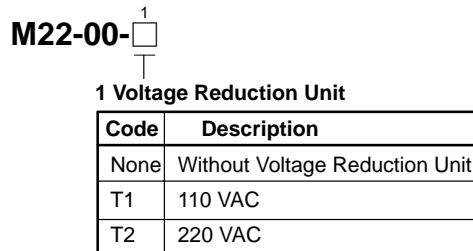

3. Socket Unit



■ List of Models

M22 Indicator (Subassembly)

Display

Appearance	IP65 oil-resistant	
	Color of Display	Model
Round/Flat  M22-F	Red	M22-FR
	Green	M22-FG
	Yellow	M22-FY
	White	M22-FW
	Blue	M22-FA
Square/Projection  M22-C	Red	M22-CR
	Green	M22-CG
	Yellow	M22-CY
	White	M22-CW
	Blue	M22-CA

Lamp

LED

Appearance	Rated voltage	LED light	6 V	12 V	24 V	24 V Super-bright
			Model			
	AC	Red	A22-6DR	---	---	---
		Green	A22-6DG	---	---	---
		Yellow (see note 2)	A22-6DY	---	---	---
		Blue	A22-6DA	---	---	---
	DC	Red	A22-6AR	---	---	---
		Green	A22-6AG	---	---	---
		Yellow (see note 2)	A22-6AY	---	---	---
		Blue	A22-6AA	---	---	---
	AC and DC	Red	---	A22-12AR	A22-24AR	A22-24ASR
		Green	---	A22-12AG	A22-24AG	A22-24ASG
		Yellow (see note 2)	---	A22-12AY	A22-24AY	A22-24ASY
		Blue	---	A22-12AA	A22-24AA	A22-24ASA

- Note:** 1. For voltage-reduction lighting, use the A22-24A□.
 2. Used when the Display color is yellow or white.

Incandescent

Rated voltage	6 VAC/VDC	14 VAC/VDC	28 VAC/VDC	130 VAC/VDC
	A22-5	A22-12	A22-24	A22-H1

Socket Unit

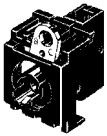
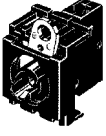
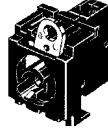
Voltage-reduction circuits		
Without Voltage Reduction Unit	With Voltage Reduction Unit	
		
Without Voltage Reduction Unit M22-00	With Voltage Reduction Unit (110 VAC) M22-00-T1	With Voltage Reduction Unit (220 VAC) M22-00-T2

- Note:** For voltage-reduction lighting, use the A22-24A□.

Specifications

■ Ratings

LED Lamp

Rated voltage	Rated current	Operating voltage
6 VDC	60 mA (20 mA)	6 VDC±5%
6 VAC	60 mA (20 mA)	6 VAC±5%
12 VAC/VDC	30 mA (10 mA)	12 VAC/VDC±5%
24 VAC/VDC	15 mA (10 mA)	24 VAC/VDC±5%

Note: The values in parentheses are for blue Indicators.

Super-bright LED Indicator

Rated voltage	Rated current	Operating voltage
24 VAC/VDC	15 mA	24 VAC/VDC±5%

Incandescent Lamp

Rated voltage	Rated current	Operating voltage
6 VAC/VDC	200 mA	5 V
14 VAC/VDC	80 mA	12 V
28 VAC/VDC	40 mA	24 V
130 VAC/VDC	20 mA	100 V

Voltage-reduction Lighting

Rated voltage	Operational voltage	Applicable lamp (BA9S/13□ gold)
110 VAC	95 to 115 VAC	LED lamp (A22-24□)
220 VAC	190 to 230 VAC	

■ Approved Standards

Recognized organization	Standards	File No.
UL, cUL (see note)	UL508	E41515
ASTA	EN60947-5-1	---

Note: UL: CSA C22 No. 14

Nomenclature

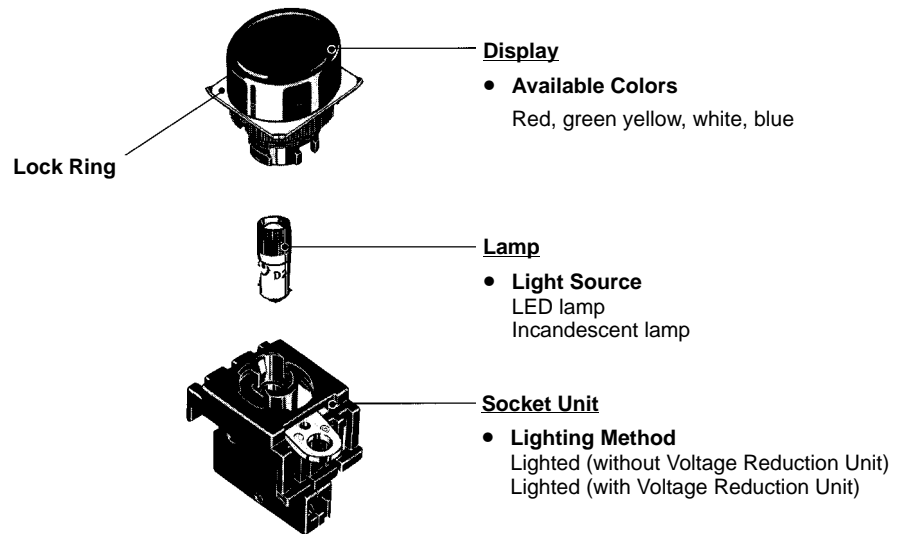

Refer to pages 181 onwards for accessories, installation, and precautions.

Dimensions

Note: All units are in millimeters unless otherwise indicated.

■ Indicators

Round/Flat M22-F

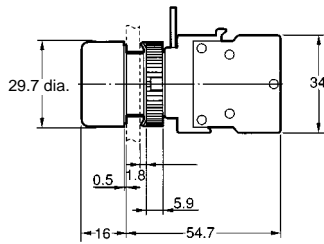

Square/Projection M22-C

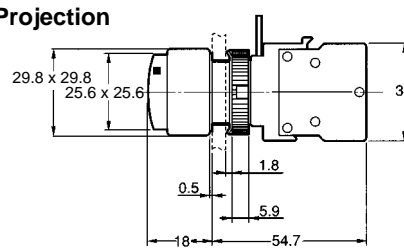

■ Terminal Arrangement

Terminal Arrangement (Bottom View)

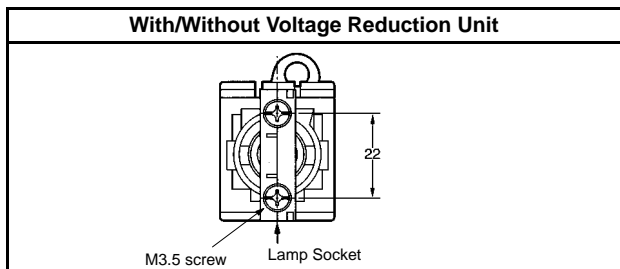

Panel Cutout Dimensions

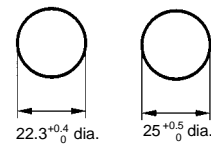

- Note:**
1. When applying coating such as paint to the panel, the dimensions should be those after the application of coating. Lock Ring is provided as a standard item.
 2. Recommended panel thickness: 1 to 5 mm.
 3. Use an A22Z-R25 Ring when mounting to a panel with 25-mm holes.

Terminal Connection

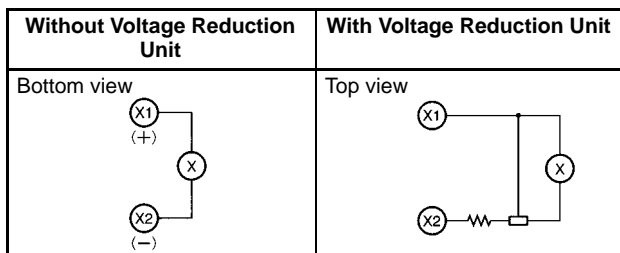

ALL DIMENSIONS SHOWN ARE IN MILLIMETERS.
 To convert millimeters into inches, multiply by 0.03937. To convert grams into ounces, multiply by 0.03527.