

Cylindrical 16-dia. Indicator

- Same basic design as the A16 Pushbutton Switch.
- UL approved (File No. E41515).



Ordering Information

■ Model Number Legend

The model numbers used to order sets of Units are illustrated below. One set comprises the Display, Case, Lamp, and Socket.

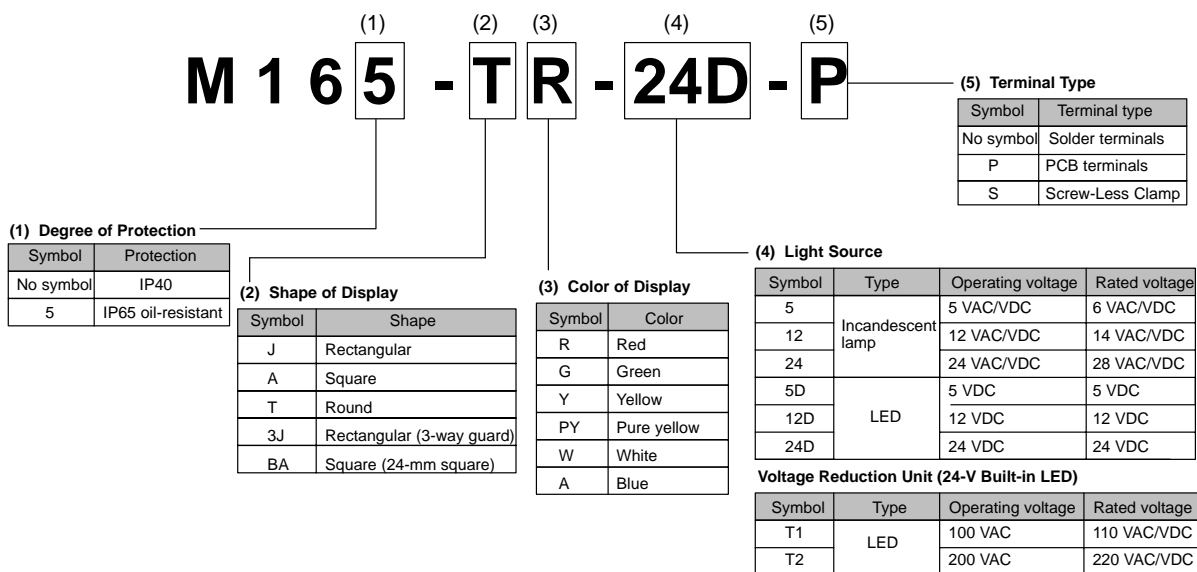

Solder terminals are available only with 100-V models.

The Voltage Reduction Unit is not available for models with PCB terminals.

■ Ordering in Combined Units

In addition to ordering as a set and ordering individually, the M16 can also be ordered as combined Units: the Display Unit (comprising the Display and the Case) and the Socket Unit (comprising the Lamp and the Socket).

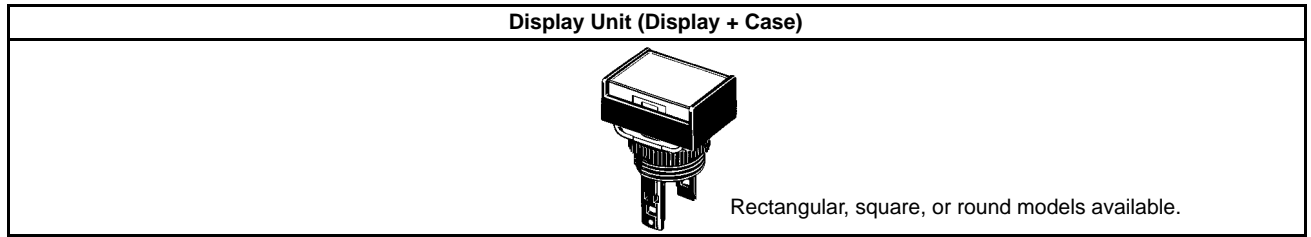

↓
Lighted Models

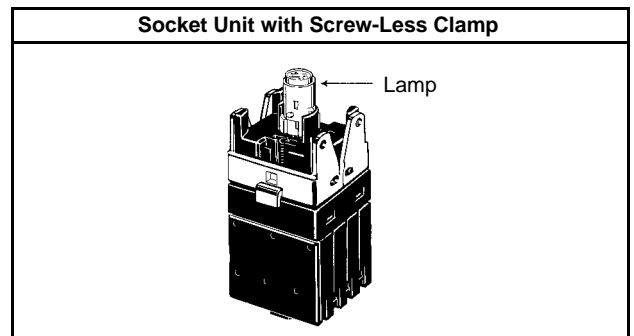
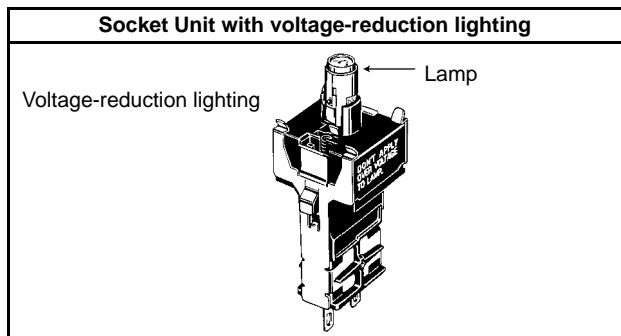

■ Ordering as a Set

The model numbers used to order sets of Units are given in the following tables. One set comprises the Display, Case, Lamp, and Socket.

M16□-J (Rectangular) Models

Solder Terminal Models

Appearance	Lighting	Rated voltage	IP40	IP65 oil-resistant	Display color symbol (See note.)
	LED without Voltage Reduction Unit	5 VDC	M16-J□-5D	M165-J□-5D	R: red Y: yellow G: green A: blue W: white PY: Pure yellow
		12 VDC	M16-J□-12D	M165-J□-12D	
		24 VDC	M16-J□-24D	M165-J□-24D	
	Incandescent lamp	5 V	M16-J□-5	M165-J□-5	
		12 V	M16-J□-12	M165-J□-12	
		24 V	M16-J□-24	M165-J□-24	

M16□-A (Square) Models

Solder Terminal Models

Appearance	Lighting	Rated voltage	IP40	IP65 oil-resistant	Display color symbol (See note.)
	LED without Voltage Reduction Unit	5 VDC	M16-A□-5D	M165-A□-5D	R: red Y: yellow G: green A: blue W: white PY: Pure yellow
		12 VDC	M16-A□-12D	M165-A□-12D	
		24 VDC	M16-A□-24D	M165-A□-24D	
	Incandescent lamp	5 V	M16-A□-5	M165-A□-5	
		12 V	M16-A□-12	M165-A□-12	
		24 V	M16-A□-24	M165-A□-24	

M16□-T (Round) Models

Solder Terminal Models

Appearance	Lighting	Rated voltage	IP40	IP65 oil-resistant	Display color symbol (See note.)
	LED without Voltage Reduction Unit	5 VDC	M16-T□-5D	M165-T□-5D	R: red Y: yellow G: green A: blue W: white PY: Pure yellow
		12 VDC	M16-T□-12D	M165-T□-12D	
		24 VDC	M16-T□-24D	M165-T□-24D	
	Incandescent lamp	5 V	M16-T□-5	M165-T□-5	
		12 V	M16-T□-12	M165-T□-12	
		24 V	M16-T□-24	M165-T□-24	

Note: Enter the desired color symbol for the Display in □.

■ Ordering Individually

Displays, Cases, Lamps, and Sockets can be ordered separately. Combinations that are not available as sets can be created using individual parts. Also, store the parts as spares for maintenance and repairs.

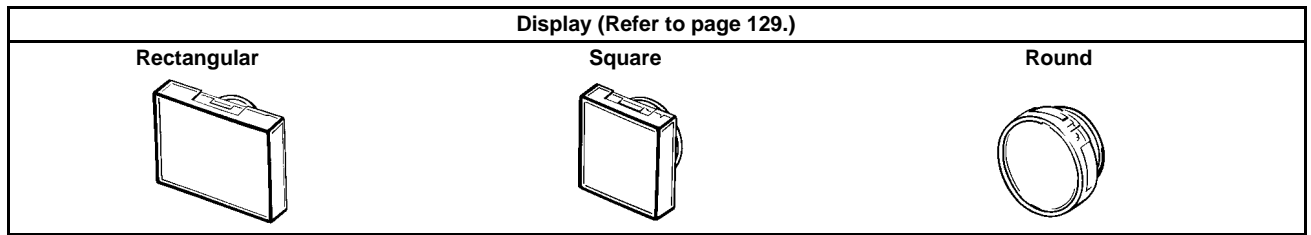

Note: Use IP40 Displays in combination with IP40 Sockets and use IP65 Displays in combination with IP65 Sockets.

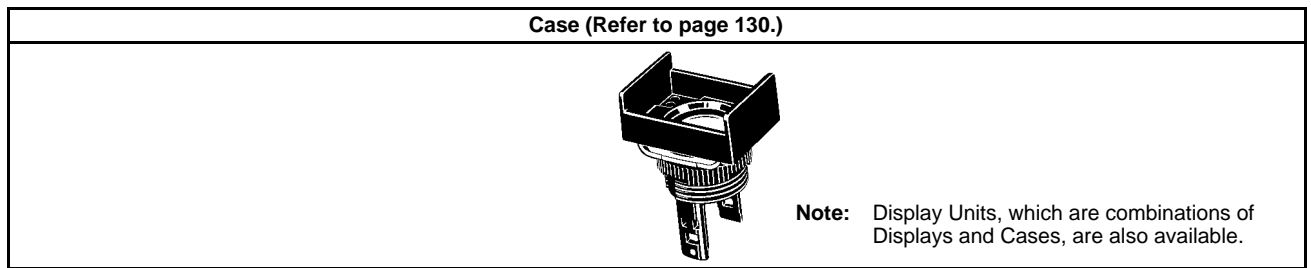

Lighted Models

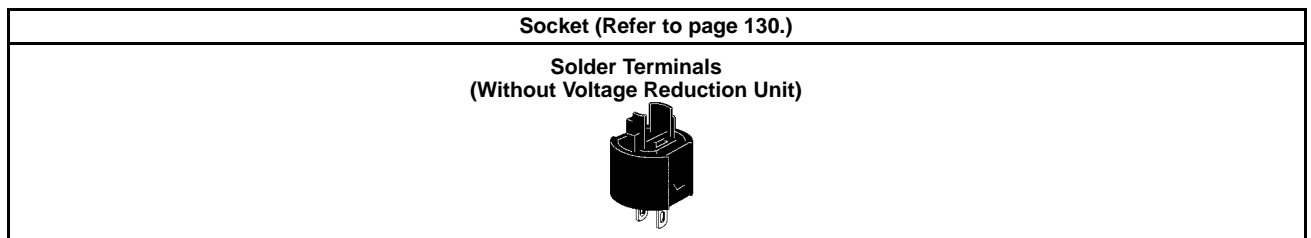
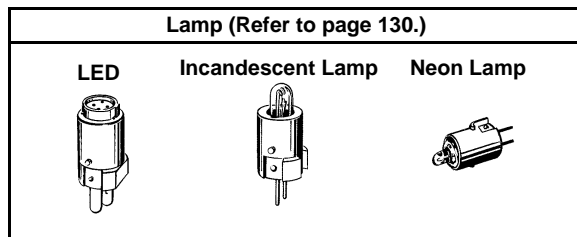

Note: Socket Units, which are combinations of Lamps and Sockets, are also available.

■ Ordering in Combined Units
Display Unit

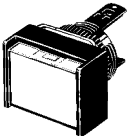
Appearance	Classification		Model number
	IP40	Rectangular (2-way guard)	A16-J□M
		Rectangular (3-way guard)	A16-3J□M
		Square	A16-A□M
		Round	A16-T□M
	IP65 oil-resistant	Rectangular (2-way guard)	A165-J□M
		Rectangular (3-way guard)	A165-3J□M
		Square	A165-A□M
		Round	A165-T□M

Enter the appropriate symbol from the following table in □.

Symbol	Color	Notes
R	Red	Available for LEDs, incandescent lamps.
Y	Yellow	
PY	Pure yellow	
A	Blue	
W	White	
GY	Green	Available for LEDs only.
G	Green	Available for incandescent lamps.

Socket Unit
Incandescent Lamp

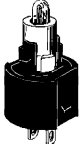
Appearance	Classification		Model number
	5 V	Solder terminals	M16-5
	12 V		M16-12
	24 V		M16-24
	5 V	PCB terminals	M16-5-P
	12 V		M16-12-P
	24 V		M16-24-P
	5 V	Screw-Less Clamp	M16-5-S
	12 V		M16-12-S
	24 V		M16-24-S

LED

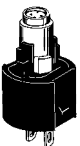
Appearance	Classification	Model number
	Solder terminals	M16-①-②
	PCB terminals	M16-①-②-P
	Screw-Less Clamp	M16-①-②-S

Enter the appropriate symbols from the following tables in ① and ②.

①

Symbol	Color
R	Red
Y	Yellow
A	Blue
W	White
G	Green

Socket Unit with Voltage-reduction Lighting
(Solder Terminals)

Appearance	Operating voltage	Model number
	100/110 VAC/VDC	M16-①-T1

Note: The operating voltage for the built-in LED is 24 VDC.

Socket Unit with Screw-Less Clamp

Appearance	Classification		Model number
	Without voltage-reduction lighting	Lighted	M16-①-②-S
		With voltage-reduction lighting (See note.)	M16-①-T1-S
	100/110 VAC/VDC		M16-①-T2-S
200/220 VAC/VDC			

Note: The operating voltage for the built-in LED in 100-V models is 24 VDC. The built-in LED in 200-V models is a super-bright LED with an operating voltage of 24 VDC.

②







Symbol	Type	Operating voltage
5D	LED	5 VDC
12D		12 VDC
24D		24 VDC

■ Ordering Individually







Displays, Cases, Lamps, and Sockets can be ordered separately. Combinations that are not available as sets can be created using individual parts. Also, store the parts as spares for maintenance and repairs.

Display







For LED-lighted Models

Sealing Appearance	IP40			IP65 oil-resistant		
	Rectangular 	Square 	Round 	Rectangular 	Square 	Round 
Color of Display						
Red	A16L-JR	A16L-AR	A16L-TR	A165L-JR	A165L-AR	A165L-TR
Yellow	A16L-JY	A16L-AY	A16L-TY	A165L-JY	A165L-AY	A165L-TY
Pure yellow	A16L-JPY	A16L-APY	A16L-TPY	A165L-JPY	A165L-APY	A165L-TPY
Green	A16L-JGY	A16L-AGY	A16L-TGY	A165L-JGY	A165L-AGY	A165L-TGY
White	A16L-JW	A16L-AW	A16L-TW	A165L-JW	A165L-AW	A165L-TW
Blue	A16L-JA	A16L-AA	A16L-TA	A165L-JA	A165L-AA	A165L-TA

Incandescent Lamps (With the exception of green, the Units are the same as for LEDs.)

Sealing Appearance	IP40			IP65 oil-resistant		
	Rectangular 	Square 	Round 	Rectangular 	Square 	Round 
Color of Display						
Red	A16L-JR	A16L-AR	A16L-TR	A165L-JR	A165L-AR	A165L-TR
Yellow	A16L-JY	A16L-AY	A16L-TY	A165L-JY	A165L-AY	A165L-TY
Pure yellow	A16L-JPY	A16L-APY	A16L-TPY	A165L-JPY	A165L-APY	A165L-TPY
Green	A16L-JG	A16L-AG	A16L-TG	A165L-JG	A165L-AG	A165L-TG
White	A16L-JW	A16L-AW	A16L-TW	A165L-JW	A165L-AW	A165L-TW
Blue	A16L-JA	A16L-AA	A16L-TA	A165L-JA	A165L-AA	A165L-TA

Neon Lamps

Sealing Appearance	IP40			IP65 oil-resistant		
	Rectangular 	Square 	Round 	Rectangular 	Square 	Round 
Color of Display						
Red	A16L-JRN	A16L-ARN	A16L-TRN	A165L-JRN	A165L-ARN	A165L-TRN
Green	A16L-JGN	A16L-AGN	A16L-TGN	A165L-JGN	A165L-AGN	A165L-TGN
White	A16L-JWN	A16L-AWN	A16L-TWN	A165L-JWN	A165L-AWN	A165L-TWN

Lamp

LED

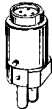
	Color	Rated voltage		
		5 VDC	12 VDC	24 VDC
	Red	A16-5DR	A16-12DR	A16-24DR
Yellow	A16-5DY	A16-12DY	A16-24DY	
Green	A16-5DG	A16-12DG	A16-24DG	
White (See note.)	A16-5DW	A16-12DW	A16-24DW	
Blue	A16-5DA	A16-12DA	A16-24DA	

Note: Use the white LED when the required illumination color is white or pure yellow.

Incandescent Lamp

	Rated voltage	6 V	14 V	28 V
	Model	A16-5	A16-12	A16-24

Neon Lamp

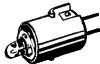
	Color of lamp	Color of Display	Rated voltage	
			110 V	220 V
	Red	White, red	A16-1NRN	A16-2NRN
Green	Green	A16-1NGN	A16-2NGN	

Case

Appearance	Classification		Model number
	IP40	Rectangular	A16-CJM
		Square	A16-CAM
		Round	A16-CTM
	IP65 oil-resistant	Rectangular	A165-CJM
		Square	A165-CAM
		Round	A165-CTM

Socket

Appearance	Classification		Model number	
	Solder terminals		M16-0	
	PCB terminals		M16-0P	
	Screw-Less Clamp		M16-S	
	Solder terminals	Voltage-reduction lighting	M16-T1	
			100 V	M16-T1-S
			200 V	M16-T2-S

Specifications

■ Ratings

Ambient operating temperature	-10°C to 55°C (with no icing or condensation)
Ambient operating humidity	35% to 85%
Ambient storage temperature	-25°C to 65°C

LED Lamp

Rated voltage	Rated current	Operating voltage	Built-in limiting resistance
5 VDC	30 mA (18 mA)	5 VDC ±5%	33 Ω (82 Ω)
12 VDC	15 mA (18 mA)	12 VDC ±5%	270 Ω (470 Ω)
24 VDC	10 mA (8.5 mA)	24 VDC ±5%	1,600 Ω (2400 Ω)

Note: The values in parentheses are for blue Pushbuttons.

■ Approved Standards

UL, cUL

Incandescent Lamp

Rated voltage	Rated current	Operating voltage
6 VAC/VDC	60 mA	5 VAC/VDC
14 VAC/VDC	40 mA	12 VAC/VDC
28 VAC/VDC	24 mA	24 VAC/VDC

Neon Lamp

Rated voltage	Rated current	Operating voltage
110 VAC	1.5 mA	100 VAC ±10%
220 VAC	1.5 mA	200 VAC ±10%

Dimensions

Note: 1. All units are in millimeters unless otherwise indicated.
 2. Refer to page 90 for details of panel cutout dimensions.

Rectangular M16-J

Solder terminals

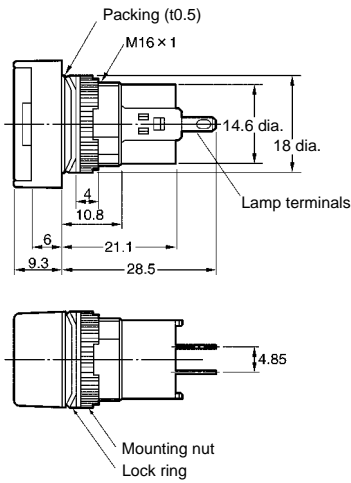
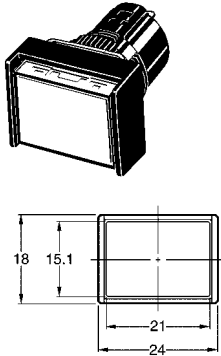

Square M16-A

Solder terminals

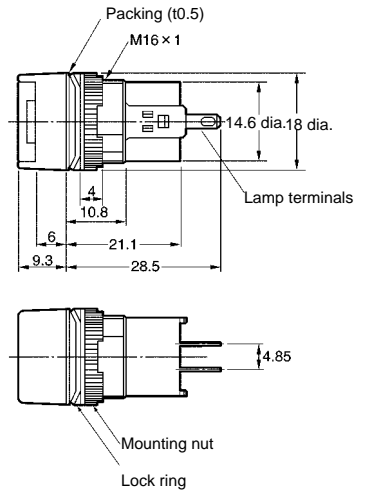
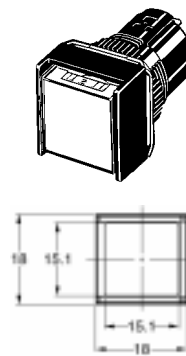

Round M16-T

Solder terminals

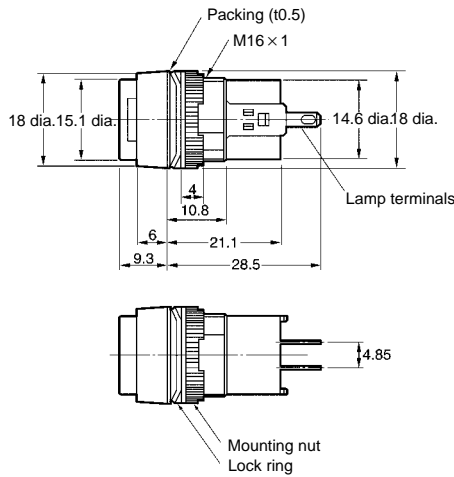
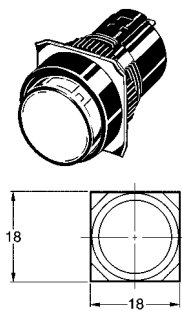

Terminal Hole Dimensions

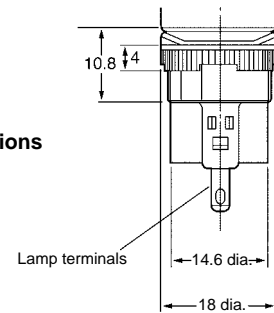
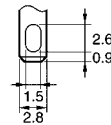

Rectangular M16-T1, T2

Voltage-reduction lighting, solder terminals

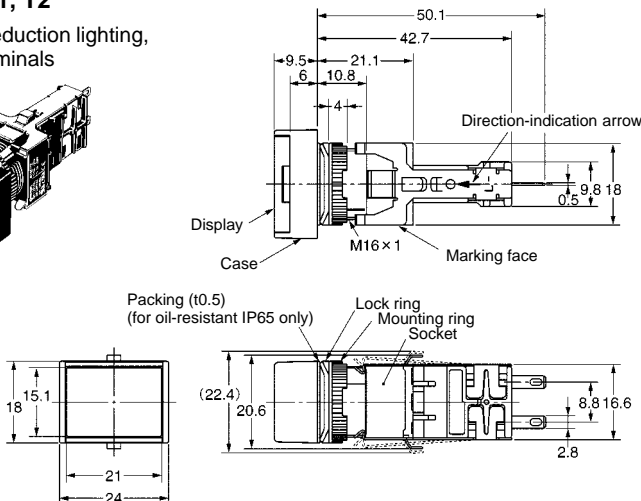
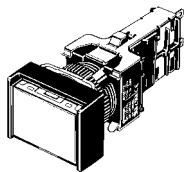

Panel Cutouts

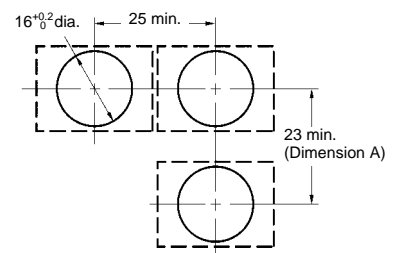

Recommended panel thickness: 0.5 to 3.2 mm

**Rectangular
M16□-S**
Screw-Less Clamp

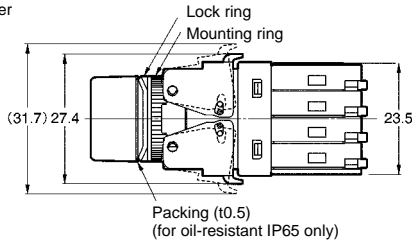
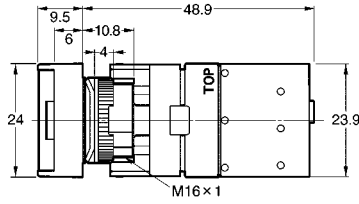
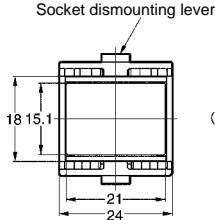
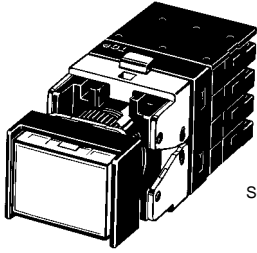

■ **Panel Cutouts
Solder Terminals**

**Solder Terminals
Rectangular M16□-J**
(Top View)

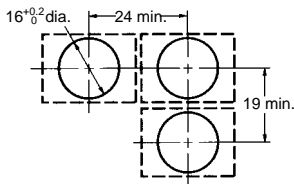

**Square M16□-A
Round M16□-T**
(Top View)

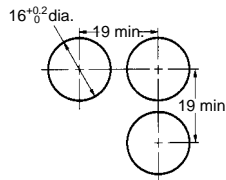

**Screw-Less Clamp
Rectangular
M16□-S**
(Top View)

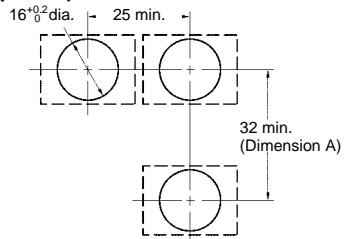

- Note:**
1. Make sure the thickness of the mounting panel is 0.5 to 3.2 mm. If, however, a Switch Guard or Dust Cover is used, the thickness of the mounting panel must be 0.5 to 2 mm.
 2. If the panel is to be finished with coating, etc., make sure that the panel meets the specified dimensions after coating.

■ **Terminal Arrangement**

Solder Terminals

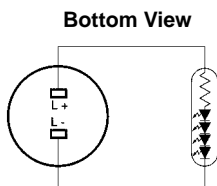

Note: The L+ is not shown on the Socket Unit.

Screw-Less Clamp

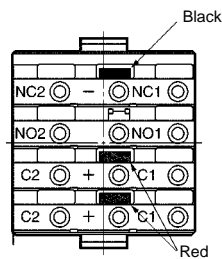

Bottom View

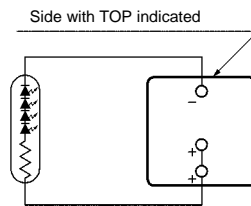

Voltage-reduction Lighting

Bottom View

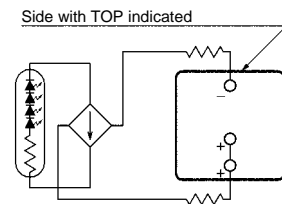

Note: Voltage-reduction lighting models with Screw-Less Clamps (A16L-□T1-2S, A16L-□T2-2S) incorporate voltage-reduction circuits.

Precautions

Correct Use

Refer to the *Common Precautions* for Pushbutton Switches on page 11.

Refer to the *Common Precautions* for the A16 and M16 on page 77.

Mounting

When mounting the Case onto the Socket Unit, ensure that the orientation is correct. Perform mounting with the ● mark on the Case and the TOP mark on the Socket Unit facing in the same direction.

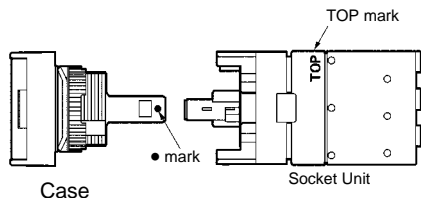

Wiring

When using stranded wire, gather the ends of the strands together before wiring.

When wiring, insert the wire until it comes into contact with something. After wiring is completed, pull on the wires to confirm that they are connected securely.

After wiring, ensure that continuous pressure is not applied to the terminals.

Refer to internal connections diagrams and confirm the terminal numbers before performing wiring.

ALL DIMENSIONS SHOWN ARE IN MILLIMETERS.

To convert millimeters into inches, multiply by 0.03937. To convert grams into ounces, multiply by 0.03527.