

Power MOS FET Relay

G3DZ

SSR Identical to the G6D in Size with a Maximum AC/DC Switching Current of 0.6 A

- Switching 0.6 A at 240 VAC or 100 VDC.
- 10- μ A current leakage max. between open output terminals.
- 2,500-VAC dielectric strength ensured between input and output terminals.
- Input resistor and varistor incorporated.
- Switching full- and half-wave rectified alternating currents.



Ordering Information

Model Number Legend:

G3DZ -
 1 2 3 4

1. Load Voltage

2: A load voltage of 240 VAC

2. Load Current

R6: A load current of 0.6 A

3. Terminal

P: PCB terminal

4. Zero Cross Function

L: Without zero cross function

Contact form	Insulation	Zero cross function	Indicator	Applicable output load	Rated input voltage	Model
SPST-NO	Photodiode array	No	No	0.6 A at	5 VDC	G3DZ-2R6PL
				3 to 264 VAC	12 VDC	
				3 to 125 VDC	24 VDC	

■ Accessories (Order Separately)

See "Dimensions" for details.

Connecting socket	P6D-04P
-------------------	---------

Specifications

■ Ratings

Input

Rated voltage	Operating voltage	Input impedance	Voltage level	
			Must operate	Must release
5 VDC	4 to 6 VDC	830 Ω ±20%	4 VDC max.	1 VDC min.
12 VDC	9.6 to 14.4 VDC	2 k Ω ±20%	9.6 VDC max.	
24 VDC	19.2 to 28.8 VDC	4 k Ω ±20%	19.2 VDC max.	

Output

Load voltage	Load current	Inrush current
3 to 264 VAC, 3 to 125 VDC	100 μ A to 0.6 A	6 A (10 ms)

■ Characteristics

Operate time	6 ms max.
Release time	10 ms max.
Output ON-resistance	2.4 Ω max.
Leakage current	10 μ A max. (at 125 VDC)
Insulation resistance	100 M Ω min. (at 500 VDC)
Dielectric strength	2,500 VAC, 50/60 Hz for 1 min between input and output
Vibration resistance	Malfunction: 10 to 55 Hz, 1.5-mm double amplitude
Shock resistance	Malfunction: 1,000 m/s ² (approx. 100G)
Ambient temperature	Operating: -30°C to 85°C (with no icing) Storage: -30°C to 100°C (with no icing)
Ambient humidity	Operating: 45% to 85%
Weight	Approx. 3.1 g

Engineering Data

Load Current vs. Ambient Temperature Characteristics

G3DZ-2R6PL

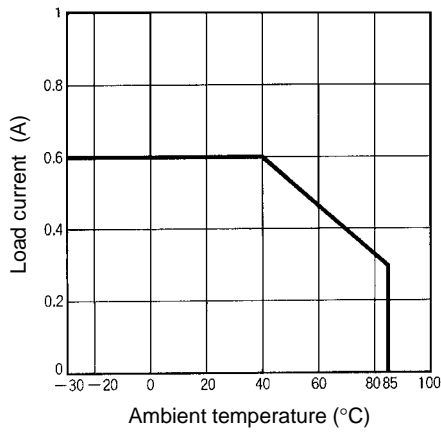

Inrush Current Resistivity

Non-repetitive (Keep the inrush current to half the rated value if it occurs repetitively.)

G3DZ-2R6PL

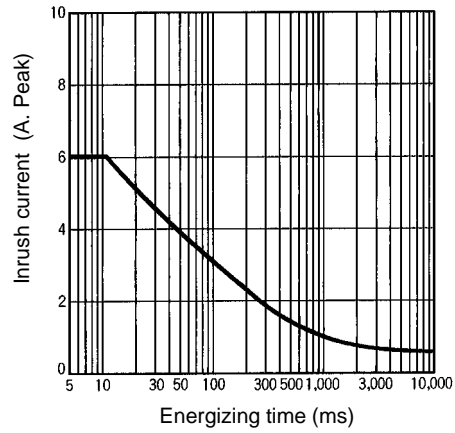

Dimensions

- Note:** 1. All units are in millimeters unless otherwise indicated.
 2. Orientation marks are indicated as follows:

G3DZ-2R6PL

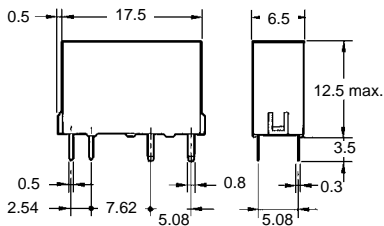
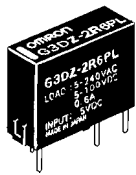

Mounting Holes (Bottom View)

Tolerance: ± 0.1

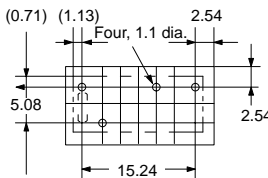

Terminal Arrangement/ Internal Connections (Bottom View)

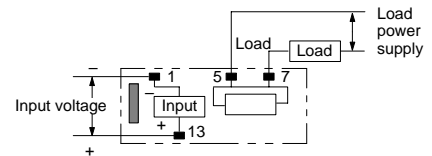

P6D-04P Connecting Socket

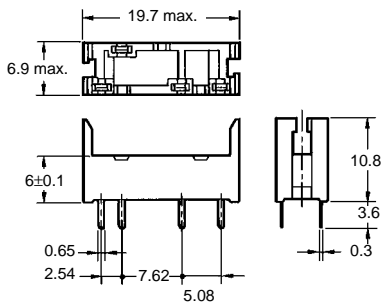
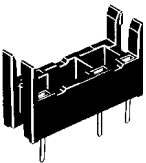

Mounting Holes (Bottom View)

Tolerance: ± 0.1

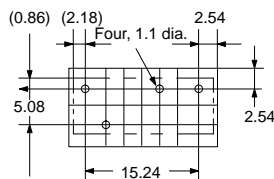

Socket Mounting Height

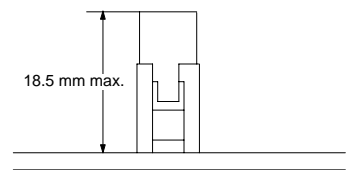

Precautions

If any reversed surge voltage is imposed on the input terminals, insert a diode in parallel to the input terminals as shown in the following circuit diagram and do not impose a reversed voltage value of 3 V or more.

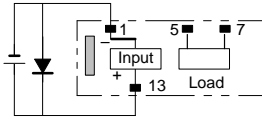

Load Connection

When connecting a load generating a high inrush current (such as a lamp load) to the MOS FET Relay, make sure that the MOS FET Relay can withstand the inrush current.

OMRON's datasheets show the non-repetitive peak value of the MOS FET Relay's inrush current durability. Normally allow 1/2 of this inrush current to flow through the MOS FET Relay. If an inrush current exceeding that value is expected, connect a quick-blowing fuse to protect the MOS FET Relays.

AC Load

No zero cross function is incorporated.

The maximum operating frequency is 10 Hz.

Forwarding/Reversing Control of Single-phase Inductive Motor

Use a MOS FET Relay with an output voltage twice as large as the supply voltage. Contact your OMRON representative before using MOS FET Relays with 200 V output.

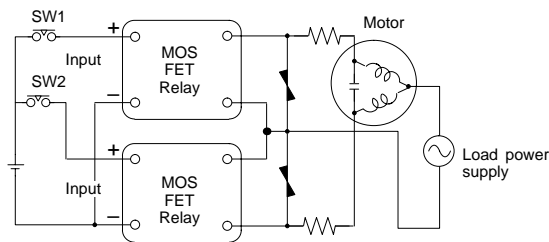

Operate SW1 for at least 30 ms after SW2 has been operated, or vice versa.

Capacitive Load

1. Use a MOS FET Relay with an output voltage twice as large as the supply voltage because the supply voltage and charge voltage of the capacitor are imposed on the MOS FET Relay at the same time when the MOS FET Relay is turned OFF.
2. Limit the charge voltage of the capacitor to 1/2 of the peak inrush current value that is allowed to flow into the MOS FET Relay.

Handling Instructions

Handle the G3DZ with care so that the G3DZ will not be damaged due to static electricity.

DC Load

If a coil load such as a solenoid or electromagnetic valve is connected to the G3DZ, connect a diode in parallel to the load to absorb counter-electromotive force.

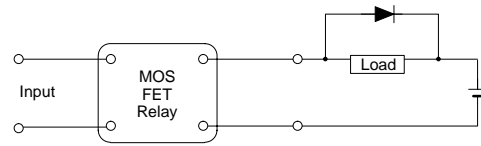

For high-speed operation:

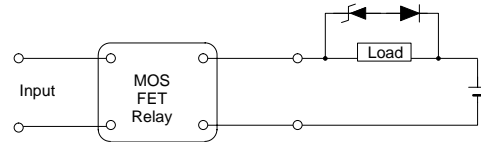

To shorten the time, connect a Zener diode and a regular diode in series as shown in the illustration above.

The G3DZ switches full-wave rectified alternating currents, half-wave rectified alternating currents, and low capacity load currents.

AC/DC Load

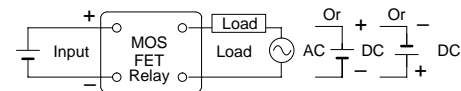

DC Load

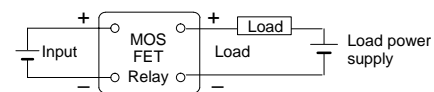

If an inductive AC load is connected to the G3DZ, connect a varistor as a surge absorber in parallel to the load.

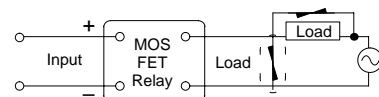

Although the G3DZ has a built-in varistor connected to the load terminals of the G3DZ to absorb noise, do not wire power lines or high-tension lines along with the lines connected to the G3DZ in a single duct or the G3DZ may be damaged or malfunction due to induction.

The surge absorption element must satisfy the following requirements.

Operating voltage	Varistor voltage	Inrush resistance
100 to 120 VAC	240 to 270 V	1,000 A min.

Operating voltage	Varistor voltage	Inrush resistance
200 to 240 VAC	440 to 470 V	1,000 A min.